

Thank you for purchasing this PENTAX **K20D** Digital Camera. Please read this manual before using the camera in order to get the most out of all the features and functions. Keep this manual safe, as it can be a valuable tool in helping you to understand all the camera capabilities.

Lenses you can use

In general, lenses that can be used with this camera are DA, D FA and FA J lenses and lenses that have an Aperture **A** (Auto) position.

To use any other lens or accessory, see p.50 and p.251.

Regarding copyrights

Images taken using the **K20D** that are for anything other than personal enjoyment cannot be used without permission according to the rights as specified in the Copyright Act. Please take care, as there are even cases where limitations are placed on taking pictures even for personal enjoyment during demonstrations, performances or of items on display. Images taken with the purpose of obtaining copyrights also cannot be used outside the scope of use of the copyright as laid out in the Copyright Act, and care should be taken here also.

Regarding trademarks

PENTAX and smc PENTAX are trademarks of PENTAX Corporation.

 SD logo and SDHC logo are trademarks.

This product includes DNG technology under license by Adobe Systems Incorporated.

 The DNG logo is either a registered trademark or trademark of Adobe Systems Incorporated in the United States and/or other countries.

All other brands or product names are trademarks or registered trademarks of their respective companies.

To users of this camera

- There is a possibility that recorded data may be erased or that the camera may not function correctly when used in surroundings such as installations generating strong electromagnetic radiation or magnetic fields.
- The liquid crystal panel used in the monitor is manufactured using extremely high precision technology. Although the level of functioning pixels is 99.99% or better, you should be aware that 0.01% or fewer of the pixels may not illuminate or may illuminate when they should not. However, this has no effect on the recorded image.

This product supports PRINT Image Matching III. PRINT Image Matching enabled digital still cameras, printers and software help photographers to produce images more faithful to their intentions. Some functions are not available on printers that are not PRINT Image Matching III compliant.

Copyright 2001 Seiko Epson Corporation. All Rights Reserved.

PRINT Image Matching is a trademark of Seiko Epson Corporation.

The PRINT Image Matching logo is a trademark of Seiko Epson Corporation.



Regarding PictBridge

PictBridge allows the user to connect the printer and digital camera directly, using the unified standard for the direct printout of images. You can print images directly from the camera through a few simple operations.

- There is a possibility that the illustrations and the display screen of the monitor in this manual are different from the actual product.

FOR USING YOUR CAMERA SAFELY

We have paid close attention to the safety of this product. When using this product, we request your special attention regarding items marked with the following symbols.

-  **Warning** This symbol indicates that violating this item could cause serious personal injuries.
-  **Caution** This symbol indicates that violating this item could cause minor or medium personal injuries, or material losses.

ABOUT THE CAMERA

Warning

- Do not disassemble or modify the camera. High voltage areas are present inside the camera, with the risk of electric shock.
- If the camera interior is exposed due to dropping or otherwise damaging the camera, never touch the exposed portion. There is the risk of electric shock.
- To avoid the risk of it being swallowed by mistake, keep the SD Memory Card out of the reach of small children. Seek medical attention immediately if a memory card is accidentally swallowed.
- Wrapping the strap around your neck is dangerous. Take care that small children do not hang the strap over their necks.
- Do not look directly at the sun through the camera with a telephoto lens attached, as viewing the sun may damage your eyes. Viewing the sun directly with a telephoto lens may lead to a loss of eyesight.
- Be sure to store the battery out of the reach of children. Placing in mouth may cause an electrical shock.
- Always use the AC adapter exclusively developed for this product, with the specified power and voltage. Using an AC adapter not exclusive to this product, or using the exclusive AC adapter with an unspecified power or voltage can cause a fire, electric shock, or camera breakdown.
- If any irregularities occur during use, such as smoke or a strange odor, stop use immediately, remove the battery or the AC adapter, and contact your nearest PENTAX Service Center. Continued use could cause a fire or electric shock.
- During thunderstorms, unplug and discontinue use of the AC adapter. Continued use could cause equipment failure, a fire, or electric shock.

 **Caution**

- Do not short the battery or dispose of the battery in fire. Do not disassemble the battery. The battery could explode or catch fire.
- Remove the battery from the camera immediately if they become hot or begin to smoke. Be careful not to burn yourself during removal.
- Some portions of the camera heat up during use. There is the risk of low temperature burns when holding such portions for long periods.
- Do not place your finger over or cover the flash with clothing when discharging the flash. Fingers or clothing may be burned.
- Depending on a user's physical condition, some users may experience itching, break out in a rash or suffer from eczema. If an abnormality occurs, immediately discontinue using the camera and seek medical attention.

PRECAUTIONS FOR BATTERY USAGE

- Only use the specified battery with this camera. Use of other batteries can cause a fire or explosion.
- Keep wires, hairpins, and other metal objects away from the + and – contacts of the battery. When storing a battery removed from the camera, be sure to attach the included protective cap to avoid shorting.
- Do not disassemble the battery. Disassembling the battery can cause explosion or leakage.
- If any leakage from the battery should come in contact with your eyes, do not rub them. Flush your eyes with clean water and get medical attention immediately.
- If any leakage from the battery should come in contact with skin or clothes, wash the affected areas thoroughly with water.
- Do not disassemble or short circuit the battery case. Do not dispose of the battery in a fire or leave the battery in a place with high temperatures. Doing so may cause the battery to become hot, catch fire or explode.
- Be sure to charge the battery with the specified battery charger.
- Remove the battery from the camera immediately if it becomes hot or begins to smoke. Be careful not to burn yourself during removal.
- Storing the battery fully charged may decrease the battery performance. Avoid storing in high temperatures.
If the battery is left inserted and the camera is not used for a long time, the battery will over-discharge and shorten the battery's usage span.
- Charging the battery a day before use or on the day of use is recommended.

PRECAUTIONS FOR BATTERY CHARGER USAGE

- Only use the battery charger D-BC50 supplied with the camera. Do not use the product at a voltage other than the specified voltage. Use with a power source or voltage other than that designed can cause a fire or electrical shock. The specified voltage is 100 - 240V AC.
- Do not use the battery charger to charge batteries other than rechargeable lithium-ion battery D-LI50. This can cause explosion or a fire or breakdown of the battery charger.
- Do not disassemble or modify the product. This can cause a fire or electrical shock.
- If the generation of smoke or strange odor from the product or other abnormality occurs, immediately discontinue using and consult a PENTAX Service Center. Continued use could cause a fire or electric shock.
- If water should happen to get inside the product, consult a PENTAX Service Center. Continuing to use the product can cause a fire or electrical shock.
- If thunderstorm should be present during use of the battery charger, unplug the power cord and discontinue use. Continuing to use the product can cause damage to the equipment, fire or electrical shock.
- Wipe off the plug of the power cord if it should become covered with dust. This can cause a fire.
- To reduce the risk of hazards, use only CSA/UL Certified power supply cord set, cord is Type SPT-2 or heavier, minimum NO.18 AWG copper, one end with a molded-on male attachment plug cap (with a specified NEMA configuration), and the other is provided with a molded-on female connector body (with a specified IEC nonindustrial type configuration) or the equivalent.
- The AC plug cord supplied with the camera is for exclusive use with the battery charger D-BC50. Do not use it with any other equipment.

Care to be Taken During Handling

- When traveling, take the Worldwide Service Network that is included in the package. This will be useful if you experience problems abroad.
- When the camera has not been used for a long time, confirm that it is still working properly, particularly prior to taking important pictures (such as at a wedding or during traveling). Pictures cannot be guaranteed if recording, playback or transferring your data to a computer, etc. is not possible due to a malfunction of your camera or recording media (SD Memory Card), etc.

- Do not clean the product with organic solvents such as thinner or alcohol benzene.
- Do not subject the camera to high temperatures or high humidity. Do not leave the camera in a vehicle, as the temperature can get very high.
- Do not store the camera with preservatives and chemicals. Storage in high temperatures and high humidity can cause mold to grow on the camera. Remove from the case and store in a dry and well-ventilated location.
- Do not subject the camera to strong vibrations, shocks, or pressure. Use a cushion to protect the camera from vibrations of motorcycles, automobiles, or ships.
- The temperature range for camera use is 0°C to 40°C (32°F to 104°F).
- The monitor may appear black under high temperatures, but will return to normal as temperatures normalize.
- The monitor may respond more slowly at low temperatures. This is due to liquid crystal properties, and is not a fault.
- Periodic inspections are recommended every one to two years to maintain high performance.
- Sudden temperature changes will cause condensation on the inside and outside of the camera. Place the camera in your bag or a plastic bag, removing the camera after temperature of the camera and surroundings are equalized.
- Avoid contact with garbage, mud, sand, dust, water, toxic gases, or salts. These could cause a camera breakdown. Wipe dry any rain or water drops on the camera.
- Refer to “Precautions When Using the SD Memory Card” (p.41) regarding the SD Memory Card.
- Use a lens brush to remove dust accumulated on the lens or viewfinder. Never use a spray blower for cleaning as it may damage the lens.
- Please contact PENTAX Service Center for professional cleaning of the CMOS sensor. (This will involve a fee.)
- Please do not press forcefully on the monitor. This could cause breakage or malfunction.
- **Precautions for D-LI50 Battery Usage:**
 - DO NOT INCINERATE, DISASSEMBLE, SHORT CIRCUIT, DISPOSE OF IN FIRE OR HEAT ABOVE 140°F / 60°C. MAY CAUSE BURST OR BURN.
 - USE DESIGNATED CHARGER ONLY.

Regarding Product Registration

In order to better serve you, we request that you complete the product registration, which can be found on the CD-ROM supplied with the camera or on the PENTAX website. Thank you for your cooperation.

Refer to the PENTAX PHOTO Browser 3/PENTAX PHOTO Laboratory 3 Operating Manual (Windows users: p.9, Mac OS users: p.10) for more information.

Memo

Contents

FOR USING YOUR CAMERA SAFELY	1
ABOUT THE CAMERA.....	1
PRECAUTIONS FOR BATTERY USAGE	2
PRECAUTIONS FOR BATTERY CHARGER USAGE	3
Care to be Taken During Handling	3
Contents	6
Composition of the Operating Manual	11
Before Using Your Camera	13
<i>K20D</i> Camera Characteristics	14
Checking the Contents of the Package.....	16
Names and Functions of Working Parts	17
Camera	17
Capture Mode	18
Playback Mode	20
Display Indicators	22
Monitor	22
Viewfinder	27
LCD Panel	29
How to Operate the Menu.....	30
Using the Mode Dial.....	32
Getting Started	33
Attaching the Strap	34
Using the Battery	35
Charging the Battery	35
Inserting/Removing the Battery	36
Battery Level Indicator	38
Approximate Image Storage Capacity and Playback Time (Exclusive Battery Fully Charged)	38
Using the AC Adapter (Optional)	39
Inserting/Removing the SD Memory Card	40
Recorded Pixels and Quality Level.....	42
Turning the Camera On and Off.....	44
Initial Settings	45
Setting the Display Language.....	45
Setting the Date and Time	48
Attaching the Lens.....	50
Adjusting the Viewfinder Diopter	52

Basic Operations 53

Basic Shooting Operation	54
Holding the Camera.....	54
Letting the Camera Choose the Optimal Settings	55
Using a Zoom Lens	59
Using the Built-in Flash	60
Taking Pictures Using the Shake Reduction Function.....	65
Turning On the Shake Reduction Function.....	66
Setting the Shake Reduction Function	67
Playing Back Still Pictures	68
Playing Back Images	68
Deleting Images	70
Deleting a Single Image.....	70

Shooting Functions 71

How to Operate the Shooting Menus	72
[Rec. Mode] Menu Setting Items	72
[C Custom Setting] Menu Setting Items	73
Shooting Fn Menu Setting Items	75
Setting the Exposure	76
Effect of Aperture and Shutter Speed.....	76
Setting the Sensitivity	78
Changing the Exposure Mode	80
Selecting the Metering Method.....	98
Adjusting the Exposure.....	100
Shooting in Multi-exposure Mode	103
Focusing	104
Using the Autofocus.....	104
Selecting the Focusing Area (AF Point).....	107
Fixing the Focus (Focus Lock).....	108
Adjusting the Focus Manually (Manual Focus).....	110
Using the AF Button	112
Shooting in Catch-in Focus Mode.....	112
Checking the Composition, Exposure and Focus Before Shooting	113
Selecting the Preview Method	113
Displaying the Preview	114
Continuous Shooting.....	117
Interval Shooting.....	120
Self-Timer Shooting	122
Remote Control Shooting (Remote Control F: Sold Separately).....	125

Using Mirror Up Function to Prevent Camera Shake	128
Changing the Shooting Conditions Automatically when Shooting (Auto Bracket).....	129
Storing User Settings	133
Using the Flash	135
<hr/>	
Compensating Flash Output	136
Allowing Shooting while Charging Flash	137
Flash Characteristics in Each Exposure Mode	138
Distance and Aperture when Using the Built-in Flash	141
DA, D FA, FA J, FA and F Lens Compatibility with the Built-in Flash.....	142
Using an External Flash (Optional)	143
Shooting Settings	153
<hr/>	
Setting the Image Processing Method in Capture Mode (Custom Image).....	154
Setting the File Format	156
Setting the JPEG Recorded Pixels	156
Setting the JPEG Quality Level	157
Setting the File Format	158
Setting the RAW Button Function	159
Setting the White Balance	160
Setting the Color Space.....	167
Playback Functions	169
<hr/>	
How to Operate the Menus During Playback.....	170
[▶ Playback] Menu Setting Items	170
[C Custom Setting] Menu Setting Items	170
Playback Fn Menu Setting Items	171
Rotating Images	172
Enlarging Playback Images	173
Displaying Multiple Images	175
Displaying a Folder	177
Comparing Images.....	178
Slideshow	179
Setting the Slideshow Display Interval.....	181
Changing Playback Display Method	182

Deleting Multiple Images	185
Deleting All Images	185
Deleting Selected Images (from Multi-image Display)	186
Deleting a Folder	188
Protecting Images from Deletion (Protect)	189
Connecting the Camera to AV Equipment	191
Processing Images	193
<hr/>	
Processing Images with Digital Filters	194
Editing RAW Images	197
Editing One RAW Image	197
Editing All RAW Images	198
Specifying the Parameters	200
Printing from the Camera	203
<hr/>	
Setting the Printing Service (DPOF)	204
Printing Single Images	204
Settings for All Images	205
Printing Using PictBridge	207
Setting Transfer Mode	208
Connecting the Camera to the Printer	209
Printing Single Images	210
Printing All Images	212
Printing Images Using the DPOF Settings	213
Disconnecting the USB Cable	213
Camera Settings	215
<hr/>	
How to Operate the [Set-up] Menu	216
[Set-up] Menu Setting Items	216
Formatting the SD Memory Card	218
Setting the Beep Setting, Date and Time, and Display Language	219
Turning the Beep On and Off	219
Changing the Date and Time and the Display Style	220
Setting the World Time	221
Setting the Display Language	224
Adjusting the Monitor and the Menu Display	225
Setting the Text Size	225
Setting the Guide Display Time	225
Adjusting the Brightness of the Monitor	226
Adjusting the Color of the Monitor (LCD Color Tuning)	226
Setting the Display for Instant Review, Live View and Digital Preview	227

Setting the Image File Naming Convention	230
Selecting the Folder Name	230
Selecting the File Number Setting	230
Setting the File Name	231
Selecting the Video Output Format and Power Settings.....	233
Selecting the Video Output Format.....	233
Setting Auto Power Off	233
Selecting a Battery.....	234
Using Pixel Mapping	235
Selecting Capture Mode Settings to Save in the Camera	236
Resetting to Default Settings	237
<hr/>	
Resetting Rec. Mode/Playback/Set-up Menu.....	238
Resetting the Custom Function Menu	239
Resetting Other Settings	240
Resetting Saved USER Settings	240
Resetting the File Name	241
Resetting the Saved AF Adjustment Value.....	241
Appendix	243
<hr/>	
Default Settings.....	244
Functions Available with Various Lens Combinations	249
Notes on [36. Using Aperture Ring]	251
Cleaning the CMOS Sensor.....	252
Removing Dust by Shaking the CMOS Sensor	252
Detecting Dust on the CMOS Sensor (Dust Alert).....	252
Removing Dust with a Blower.....	254
Optional Accessories	256
Error Messages	261
Troubleshooting.....	264
Main Specifications	266
Glossary.....	270
Index.....	275
WARRANTY POLICY.....	280

Composition of the Operating Manual

This Operating Manual contains the following chapters.

1 Before Using Your Camera

Explains camera characteristics, accessories and the names and functions of various parts.

2 Getting Started

Explains your first steps from purchasing the camera to taking pictures. Be sure to read it and follow the instructions.

3 Basic Operations

Explains the procedures for taking and playing back still pictures.

4 Shooting Functions

Explains the shooting-related functions.

5 Using the Flash

Explains how to use the built-in flash and the external flash.

6 Shooting Settings

Explains the procedures for configuring image processing and setting the save format.

7 Playback Functions

Explains the procedures for playing back, deleting, and protecting still pictures.

8 Processing Images

Explains the procedures for using image filters and processing pictures taken in RAW format.

9 Printing from the Camera

Explains the procedures for setting the print settings and printing still pictures while directly connected to a printer.

10 Camera Settings

Explains the procedures for changing the camera settings, such as the monitor settings and the image file naming convention.

11 Resetting to Default Settings

Explains the procedure for resetting all settings to their default settings.

12 Appendix

Explains troubleshooting, introduces optional accessories and provides various resources.

1

2

3

4

5

6

7

8



9

10

11

12

The symbols used in this Operating Manual are explained below.

	Shows reference page number explaining a related operation.
	Shows useful information.
	Shows precautions to take when operating the camera.

1 Before Using Your Camera

Check the package contents and names and functions of working parts before use.

<i>K20D</i> Camera Characteristics	14
Checking the Contents of the Package	16
Names and Functions of Working Parts	17
Display Indicators	22
How to Operate the Menu	30
Using the Mode Dial	32

When using menus and Fn menu, items which cannot be changed due to camera settings appear gray and cannot be selected.

K20D Camera Characteristics

1

Before Using Your Camera

- Features a 23.4×15.6 mm CMOS sensor with approximately 14.6 million effective pixels for high precision and a wide dynamic range.
- Features Shake Reduction (SR), an image sensor shifting shake reduction system. This enables you to capture sharp pictures with minimal camera shake regardless of the lens type.
- Features an AF sensor with 11 focusing points. The central 9 are wide cross area sensors.
- Provides high-speed continuous shooting up to a maximum of approximately 21 frames per second.
- Features a viewfinder similar to that of a conventional 35 mm camera, with a magnification of approximately 0.95 and field of view of approximately 95%, for easier manual focusing. Also features a superimpose function in which the AF points on the viewfinder illuminate red.
- Features a large 2.7-inch monitor with approximately 230,000 dots, a wide viewing angle and brightness and color adjusting function for high-precision viewing performance.
- Features a live view function for shooting while viewing the subject in real-time on the monitor.
- A user-friendly design has been implemented in various parts of the camera. The large text, high-contrast monitor and easy-to-use menus make the camera easier to operate.
- Dials, buttons, body joints, and retractable parts of the camera are splash and dust resistant.
- The CMOS sensor features a special SP coating against dust deposit. The Dust Removal function also shakes the CMOS for removing collected dust.
- Supports the optional Battery Grip D-BG2 with vertical shutter release button. If a battery (D-LI50) is inserted in both the camera and grip, the battery with more power is prioritized. This enables you to get the best camera performance for an extended period. A menu item also allows you to prioritize a battery and use its full power before switching to the other battery.
- Features Custom Image with options such as Fine Sharpness and Filter Effect. These options allow you to make detailed settings, enabling a wider range of expression.
- Records in the versatile JPEG format or the high quality and fully editable RAW format. You can also select JPEG+RAW and record in both formats. Pictures taken in RAW format can be easily processed internally by the camera.

- Features Hyper-program and Hyper-manual modes that let you take pictures with the intended exposure. Also features Sensitivity Priority mode **Sv** that automatically adjusts aperture and shutter speed according to the set sensitivity, and Shutter & Aperture Priority mode **TAv** that automatically adjusts sensitivity according to the set aperture and shutter speed.

The captured area (view angle) will differ between the **K20D** and 35 mm SLR cameras even if the same lens is used because the format size for 35 mm film and CMOS sensor are different.

Sizes for 35 mm film and CMOS sensor

35 mm film : 36×24 mm

K20D CMOS sensor : 23.4×15.6 mm

Angles of view being equal, the focal length of a lens used with a 35 mm camera must be approximately 1.5 times longer than that of **K20D**. To obtain an angle of view framing the same area, divide the focal length of the 35 mm lens by 1.5.

Example) To capture the same image as a 150 mm lens attached to a 35 mm camera

$$150 \div 1.5 = 100$$

Use a 100 mm lens with the **K20D**.

Inversely, multiply the focal length of the lens used with **K20D** by 1.5 to determine the focal length for 35 mm cameras.

Example) If 300 mm lens is used with **K20D**

$$300 \times 1.5 = 450$$

Focal length is equivalent to a 450 mm lens on a 35 mm camera.

Shake Reduction (SR)

Shake Reduction (SR) on the **K20D** features a PENTAX original system which uses magnetic force to move the image sensor at high speeds, compensating camera shake.

The camera may generate some operating noise when it is shaken, such as when changing the composition of a picture. It is not a malfunction.

Checking the Contents of the Package

The following accessories are packaged with your camera. Check that all accessories are included.

1

Before Using Your Camera



Hot shoe cover F κ
(Installed on camera)

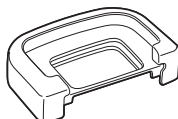

Eyecup F p
(Installed on camera)



ME Viewfinder cap



Sync socket 2P cap
(Installed on camera)

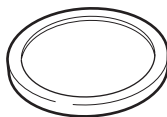

Body mount cover
(Installed on camera)

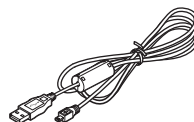

USB cable
I-USB17

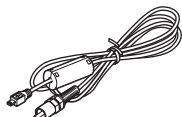

Video cable
I-VC28

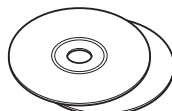

Software (CD-ROM)
S-SW74, S-SW75

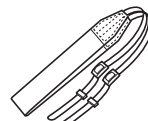

Strap
O-ST53

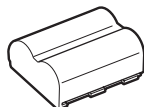

Rechargeable lithium-ion
D-LI50 battery

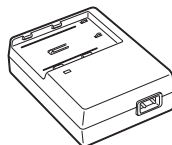

Battery charger
D-BC50



AC plug cord

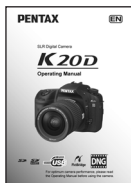

Operating Manual
(this manual)

Names and Functions of Working Parts

Camera

1

Before Using Your Camera

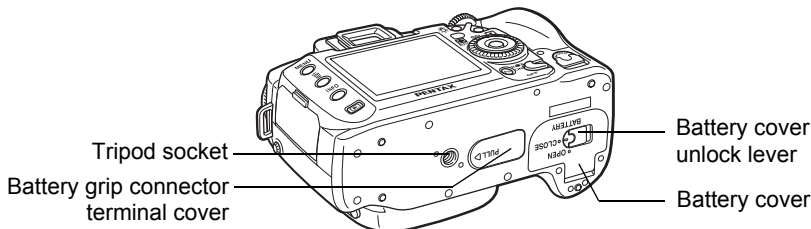
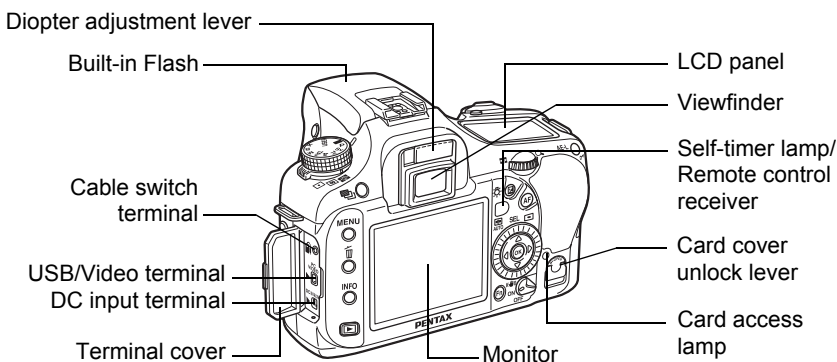
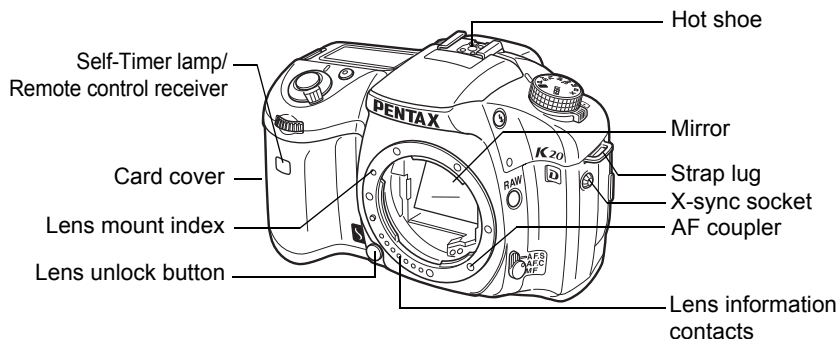

Capture Mode

Functions of buttons, dials and levers used during shooting are noted.

* The factory default settings are explained here. Depending on the button or dial, these settings can be changed in the [C Custom Settings] menu (p.73).

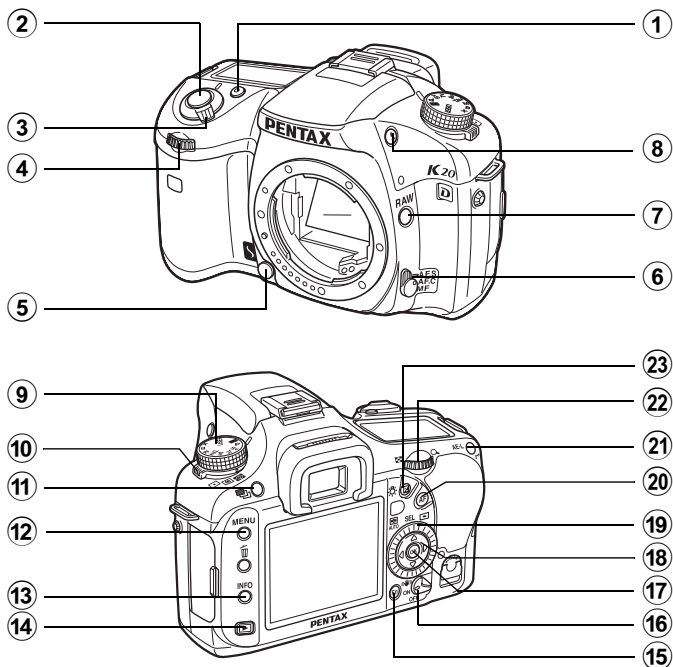

① Green button

Sets the Exposure mode to Automatic Exposure (p.85, p.92, p.95) and resets the settings (p.101, p.136).

② Shutter release button

Press to capture images. (p.57)

③ Main switch













Move to turn the power on/off (p.44) or to preview (p.114).

④ Front e-dial

Sets shutter speed and EV compensation values.

⑤ Lens unlock button

Press to detach lens. (p.51)









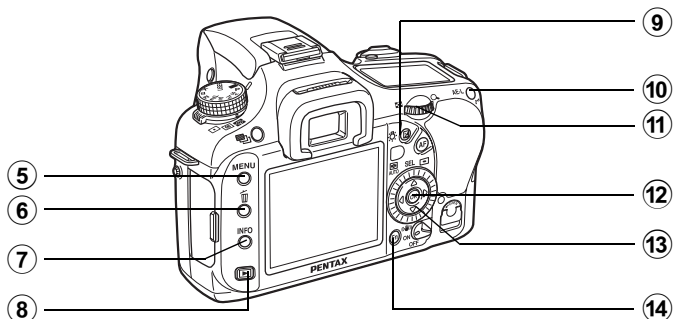
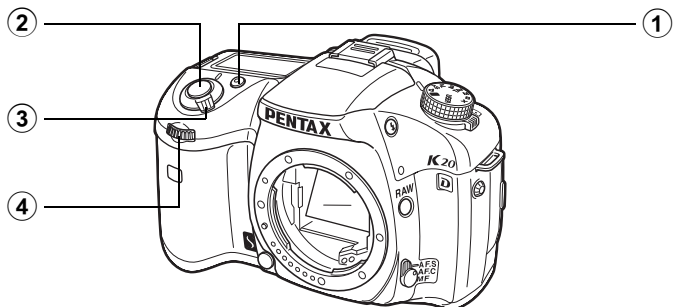

- 6 Focus mode lever**
Switches between autofocus mode (**A.F.C.**, **A.F.S.**) (p.104) and manual focus mode (**MF**) (p.110).
- 7 RAW button**
Saves JPEG and RAW file by default. (p.158, p.159)
- 8  UP button**
Press to pop up the built-in flash. (p.60)
- 9 Mode dial**
Changes the Exposure mode. (p.32)
- 10 Metering mode lever**
Changes the Metering mode. (p.98)
- 11  button**
Sets Exposure bracket shooting. (p.129)
- 12 MENU button**
Displays the [ Rec. Mode] menu (p.72). Next, press the four-way controller () to display [ Playback] menu (p.170), [ Set-up] menu (p.216) and [**C** Custom Setting] menu (p.73).
- 13 INFO button**
Press to show shooting information on the monitor. (p.23)
- 14  button**
Switches to the Playback mode. (p.68)
- 15 Fn button**
Press to display the Fn menu. (p.75)
- 16 Shake Reduction switch**
Turns the Shake Reduction function on or off. (p.65)
- 17 OK button**
Saves the setting you selected in the menu.
Press when menu is not displayed to display the currently selected sensitivity in the LCD panel and viewfinder.
- 18 Four-way controller (   )**
Use this to move cursor or change items in menus and Fn menu.
- 19 AF point switching dial**
Sets focus area. (p.107)
- 20 AF button**
Focuses on the target before metering. (p.104)
- 21 AE-L button**
Locks the exposure before shooting. (p.102)
- 22 Rear e-dial**
Sets the aperture and sensitivity values.
- 23  button**
Turn the front e-dial while pressing this button to set the EV compensation value. (p.100)
Press to illuminate the LCD panel. (p.29)

Playback Mode

Functions of buttons, dials and levers used during playback are noted.

* The factory default settings are explained here. Depending on the button or dial, these settings can be changed in the [**C** Custom Settings] menu (p.73).



- ① **Green button**
Press in Enlarged view to increase the magnification. (p.173)
- ② **Shutter release button**
Press halfway to switch to Capture mode.
- ③ **Main switch**
Move to turn the camera on and off. (p.44) Set to the  position to switch to Capture mode and preview.
- ④ **Front e-dial**
Use it to display the previous or next image during playback (p.69, p.173) or adjust the digital filter (p.194).
- ⑤ **MENU button**
Press to display the [ Playback] menu (p.170). Next, press the four-way controller () to display [ Set-up] menu (p.216), [ Custom Setting] menu (p.73) and [ Rec. Mode] menu (p.72).
- ⑥ ** button**
Press to delete images. (p.70)
- ⑦ **INFO button**
Press to show shooting information on the monitor. (p.25)
- ⑧ ** button**
Press to switch to Capture mode.
- ⑨ ** button**
Press in Enlarged view to decrease the magnification. (p.173)
- ⑩ ** button**
Press to protect images from being accidentally erased. (p.189)
- ⑪ **Rear e-dial**
Use it to enlarge an image (p.173) or display multiple images at the same time (p.175).
- ⑫ **OK button**
Saves the setting you selected in the menu or playback screen.
- ⑬ **Four-way controller ()**
Use it to move cursor or change items in menus, Fn menu and playback screen.
- ⑭ **Fn button**
Press to display the Fn menu. (p.171)

Display Indicators

Monitor

1

Before Using Your Camera

The following indicators appear on the monitor depending on the status of the camera.

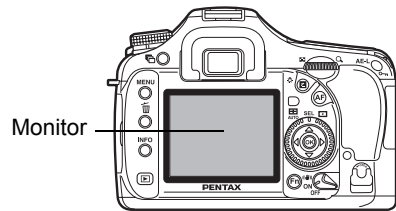

At Start-up or when Operating the Mode Dial

Guides appear on the monitor for 3 seconds when the camera is switched on or the mode dial is turned.



Select Off for [Guide display] in [Set-up] menu to not show indicators. (p.216)

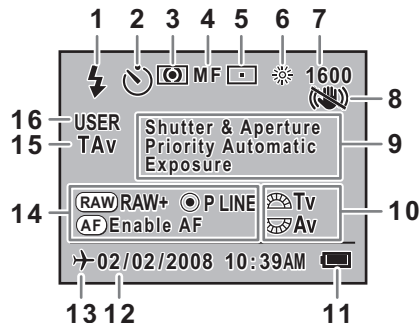

- | | |
|---|-----------------------------|
| 1 Flash mode (Active mode appears) (p.61) | 8 Shake Reduction (p.65) |
| 2 Drive mode/Auto bracket/Multi-exposure (p.75) | 9 Exposure mode name (p.32) |
| 3 AE metering (p.98) | 10 e-dial guide |
| 4 Focus mode (p.104) | 11 Battery level |
| 5 AF point position (p.107) | 12 Date and time (p.220) |
| 6 White balance (p.160) | 13 World Time (p.221) |
| 7 Sensitivity (p.78) | 14 Button guide |
| | 15 Exposure mode |
| | 16 USER mode |

* Indicators 3, 5, 6 and 7 only appear when a setting other than the default setting is selected. 8 only appears when Shake Reduction is Off. 13 only appears when World Time is On.

Capture Mode

Press the **INFO** button in Capture mode to display the capture function settings on the monitor for 30 seconds.

Press the four-way controller (**▲▼**) while displayed to switch to Detailed information display.

● Detailed information display (p.1)

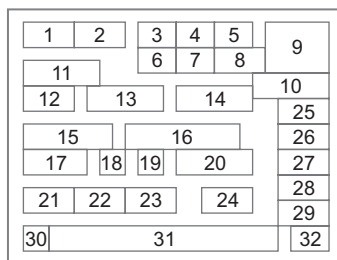
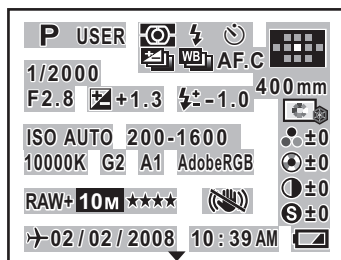

- | | |
|---|--|
| <ul style="list-style-type: none"> 1 Exposure mode (p.32) 2 USER mode (p.133) 3 AE metering (p.98) 4 Flash mode (p.61) 5 Drive mode (p.75) 6 Exposure bracket (p.129)/
Multi-exposure (p.103) 7 Extended bracket (p.131) 8 Focus mode (p.104) 9 AF point position (p.107) 10 Lens focal length (p.65) 11 Shutter speed (p.76) 12 Aperture (p.77) 13 EV compensation (p.100) 14 Flash exposure compensation
(p.136) 15 Sensitivity (p.78) | <ul style="list-style-type: none"> 16 ISO correction in AUTO (p.78) 17 White balance (p.160) 18 GM compensation (p.162) 19 BA compensation (p.162) 20 Color Space 21 File format (p.158) 22 JPEG recorded pixels (p.156) 23 JPEG quality (p.157) 24 Shake Reduction (p.65) 25 Image Tone (p.154) 26 Saturation/Filter Effect (p.154) 27 Hue/Toning (p.154) 28 Contrast (p.154) 29 Sharpness/Fine Sharpness
(p.154) 30 World Time (p.221) 31 Date and time (p.220) 32 Battery power (p.38) |
|---|--|

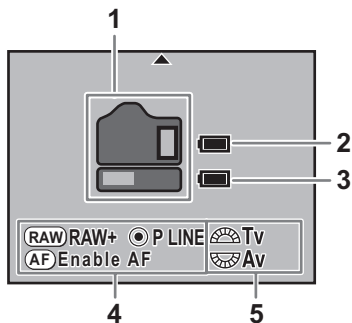
● Detailed information display (p.2)

- 1 Battery usage condition (p.234)
- 2 Camera battery power (p.38, p.234)
- 3 Grip battery power (p.38, p.234)
- 4 Button guide
- 5 e-dial guide

Playback Mode

Every time you press the **INFO** button during playback, the camera switches screen displays in the following order: Standard display, Histogram display, Detailed information display and No information display (image only).



You can change the information initially displayed by pressing the button.

● Detailed information display

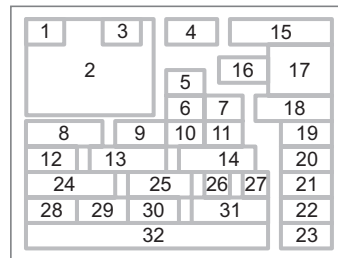
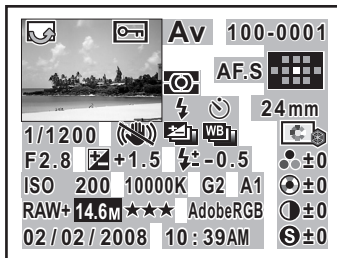

- | | | | |
|----|---------------------------------|----|---------------------------------|
| 1 | Rotation information | 17 | AF point position |
| 2 | Captured image | 18 | Lens focal length |
| 3 | Protect | 19 | Image Tone |
| 4 | Exposure mode | 20 | Saturation/Filter Effect |
| 5 | Metering mode | 21 | Hue/Toning |
| 6 | Flash mode | 22 | Contrast |
| 7 | Drive mode | 23 | Sharpness/Fine Sharpness |
| 8 | Shutter speed | 24 | Sensitivity |
| 9 | Shake Reduction | 25 | White balance/Color temperature |
| 10 | Exposure bracket/Multi-exposure | 26 | GM compensation |
| 11 | Extended bracket | 27 | BA compensation |
| 12 | Aperture | 28 | File format |
| 13 | EV compensation | 29 | JPEG recorded pixels |
| 14 | Flash exposure compensation | 30 | JPEG quality |
| 15 | Folder No./File No. | 31 | Color Space |
| 16 | Focus mode | 32 | Shooting date/time |

* Indicators 6 (Flash mode) and 14 (Flash exposure compensation) only appear for images in which the flash was discharged.

1

Before Using Your Camera

● Histogram Display

The **K20D** features two histogram displays. The “Brightness histogram” shows the distribution of brightness and the “RGB histogram” shows the distribution of color intensity. Press the four-way controller (▲▼) to switch between “Brightness histogram” and “RGB histogram”.

1

Before Using Your Camera

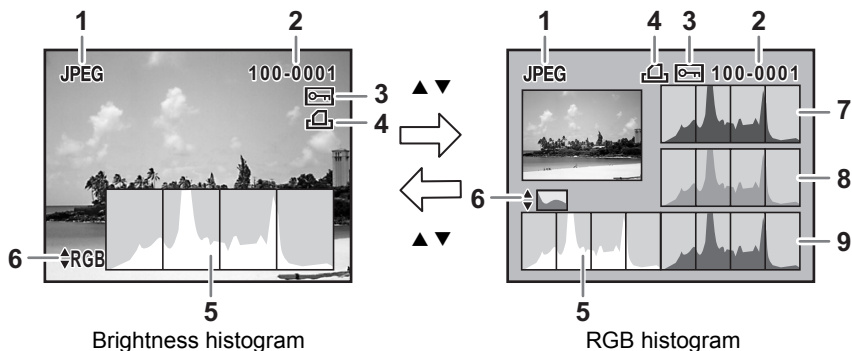

- | | | | |
|---|---|---|---|
| 1 | File Format | 6 | Switch Brightness histogram/
RGB histogram |
| 2 | Folder No./File No. of the image
(p.230) | 7 | Histogram (R) |
| 3 | Protect icon (p.189) | 8 | Histogram (G) |
| 4 | DPOF settings (p.204) | 9 | Histogram (B) |
| 5 | Histogram (Brightness) (p.182) | | |

* Indicator 4 (DPOF settings) only appears for images with DPOF settings.



Areas where blooming or dark portions blink if [Bright/Dark area] warning is set to On in [Playback display] in the [▶ Playback] menu. (p.182)

Viewfinder

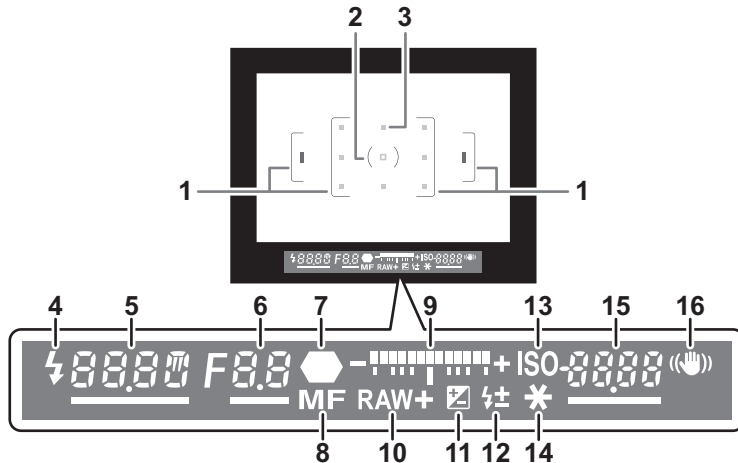

- 1 AF frame (p.52)
- 2 Spot metering frame (p.98)
- 3 AF point (p.107)
- 4 Flash status (p.60)
Appears when flash is available and blinks when flash is recommended but not set or is being charged.
- 5 Shutter speed (p.76)
Shutter speed when capturing or adjusting (underlined when shutter speed can be adjusted with the front e-dial).
- 6 Aperture (p.77)
Aperture when capturing or adjusting (underlined when aperture can be adjusted with the rear e-dial).
- 7 Focus indicator (p.56)
Appears when image is focused.
Blinks when the subject is not in focus.
- 8 Manual focus (p.110)
Appears when focus mode is **MF**.
- 9 EV bar (p.94, p.100)
Shows the EV compensation values or difference between the appropriate and current exposure values when Exposure mode is set to **M**.

- 10** File format (p.158)
Displays the image save format in RAW/RAW+ format.
Not displayed in JPEG format.
- 11** EV compensation (p.100)
Appears when EV compensation is available or in use.
- 12** Flash exposure compensation (p.136)
Appears when Flash exposure compensation is in use.
- 13** Sensitivity display
Appears when sensitivity is displayed.
- 14** AE lock indicator (p.102)
Appears during AE lock.
- 15** Number of recordable images/EV compensation/Confirm sensitivity
Show the number of recordable images with current file format (p.158),
JPEG recorded pixels (p.156) and JPEG quality (p.157).
EV compensation value appears when EV compensation is being adjusted
(p.100).
ISO sensitivity appears if Sensitivity Priority Mode/Shutter & Aperture
Priority Mode is set.
- 16** Shake Reduction (p.65)
Appears during Shake Reduction.



- The AF point in use for autofocus is superimposed in red when the shutter release button is pressed halfway. (p.107)
- When [13. AF Button Function] is set to [Cancel AF] in the [**C** Custom Setting] menu, press the **AF** button to display **MF** in the viewfinder.
- When set to a mode other than Sensitivity Priority Mode/Shutter & Aperture Priority Mode, press the **OK** button to display the ISO sensitivity in 15. (p.79)
- When set to Sensitivity Priority Mode/Shutter & Aperture Priority Mode, press the **OK** button to display the number of recordable images in 15.

LCD Panel

The following information appears in the LCD panel on top of the camera.

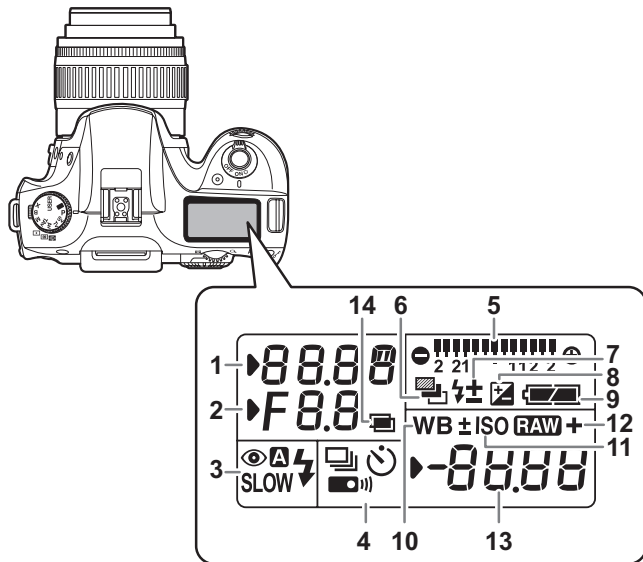

- | | |
|--|---|
| <p>1 Shutter speed (p.76)</p> <p>2 Aperture (p.77)</p> <p>3 Flash mode (p.60)</p> <p>⚡ : Built-in flash is ready
(when blinking, flash should be used)</p> <p>👁️ : Red-eye reduction flash on</p> <p>A : Auto discharge</p> <p>SLOW: Slow-speed sync</p> <p>W : Wireless</p> <p>4 Drive mode (p.75)</p> <p>☐ : Single frame shooting</p> <p>📄 : Continuous shooting</p> <p>🕒 : Self-timer shooting</p> <p>📡 : Remote control shooting</p> <p>5 EV bar (p.94, p.100)</p> | <p>6 Auto bracket (p.129)
(blinks when Exposure Bracket and Extended Bracket are both set)</p> <p>7 Flash exposure compensation (p.136)</p> <p>8 EV compensation (p.100)</p> <p>9 Battery level</p> <p>10 White balance (p.160)
(Not displayed when set to Auto)</p> <p>± : White balance correction</p> <p>11 Sensitivity display
Appears when sensitivity is displayed.</p> <p>12 RAW : RAW capture</p> <p>RAW + : RAW+JPEG capture</p> <p>13 Recordable image no./
EV compensation/PC (Pb)
(PC: Personal Computer (mass storage), Pb: PictBridge)</p> <p>14 Multi-exposure (p.103)</p> |
|--|---|



Press the button to illuminate the LCD panel. You can set it to not illuminate in [27. Illuminate LCD panel] in the [C Custom Setting] menu.

How to Operate the Menu

This section explains operation methods for [CAMERA] Rec. Mode] menu, [PLAYBACK] Playback] menu, [SETUP] Set-up] menu and [CUSTOM] Custom Setting] menu.

1

Before Using Your Camera

Displaying the Menu screen

1 Press the MENU button in Capture mode.

The [CAMERA] Rec. Mode] menu appears on the monitor.

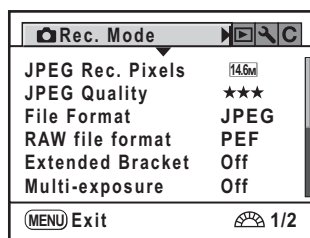
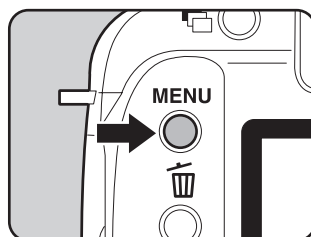

2 Press the four-way controller (▶).

The [PLAYBACK] Playback] menu, [SETUP] Set-up] menu and [CUSTOM] Custom Setting] menu appear in order each time the four-way controller is pressed. (The screen for the [SETUP] Set-up] menu is shown on the right.)

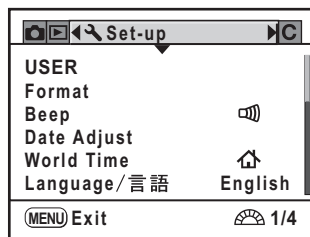

Selecting and Setting a Menu Item

Procedure to set the [JPEG Quality] on the [📷 Rec. Mode] menu is explained as an example.

3 Use the four-way controller (▲▼) to choose an item.

Turn the front e-dial to navigate the menu a page at a time.

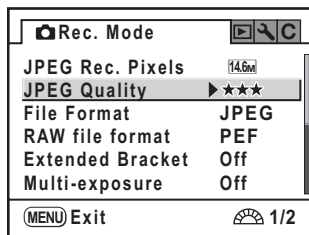

4 Press the four-way controller (▶).

Quality levels available when recording in JPEG format are displayed.

Press the four-way controller (▶) to move to the pop-up menu if there is one.

When the quality level is changed, the number of recordable images at that quality level appears at the top right of the screen.

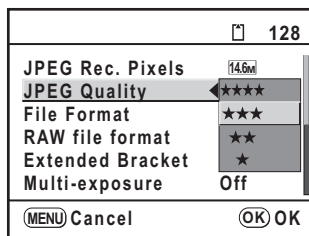

5 Use the four-way controller (▲▼) to select a setting.

6 Press the OK button.

The camera returns to the menu screen. Next, set other items. Press the **MENU** button to return to Capture or Playback mode.

Caution Even after you press the **MENU** button and close the menu screen, your settings will not be saved if the camera is turned off improperly (such as by removing the battery while the camera is on).

- memo**
- You can use the front e-dial to display the previous/next page and the rear e-dial to switch among the [📷 Rec. Mode] menu, the [▶ Playback] menu, the [⚙️ Set-up] menu, and [C Custom Setting] menu when no pop-up menu is displayed.
 - If the **MENU** button is pressed in Capture mode, the [📷 Rec. Mode] menu appears. If the **MENU** button is pressed in Playback mode, the [▶ Playback] menu appears.

Using the Mode Dial

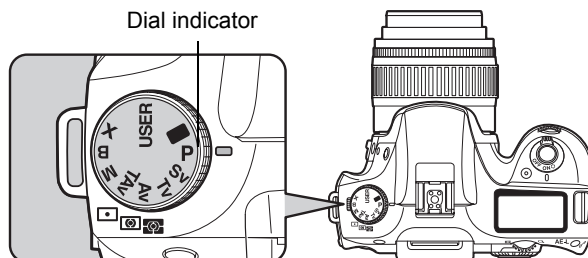

You can switch the Exposure mode by setting the icons on the mode dial to the dial indicator.

Item	Function	Page
USER (USER)	Lets you capture images with settings that you set.	p.133
 (Green)	Automatically sets shutter speed and aperture to the proper exposure according to Program line when taking pictures.	p.83
P (Hyper-program)	Automatically sets shutter speed and aperture to the proper exposure according to Program line when taking pictures. You can use the front and rear e-dials to easily switch between shutter priority and aperture priority.	p.84
Sv (Sensitivity Priority)	Automatically sets the shutter speed and aperture to the proper exposure according to the set sensitivity.	p.85
Tv (Shutter Priority)	Lets you set the desired shutter speed to freeze or emphasize subject movement.	p.87
Av (Aperture Priority)	Set aperture for controlling the depth of field.	p.89
TA v (Shutter & Aperture Priority)	Automatically sets the sensitivity so that the selected shutter speed and aperture will give the proper exposure according to the brightness of the subject.	p.91
M (Hyper-manual)	Lets you set shutter speed and aperture to capture the picture with creative intent.	p.93
B (Bulb)	Lets you capture images that require slow shutter speeds such as fireworks and night scenes.	p.96
X (Flash X-sync speed)	The shutter speed is locked at 1/180 seconds. Use this when using an External flash that does not automatically change the shutter speed.	p.97

2 Getting Started

This chapter explains your first steps from purchasing the camera to taking pictures. Be sure to read it and follow the instructions.

Attaching the Strap	34
Using the Battery	35
Inserting/Removing the SD Memory Card	40
Turning the Camera On and Off	44
Initial Settings	45
Attaching the Lens	50
Adjusting the Viewfinder Diopter	52

Attaching the Strap

- 1** Pass the end of the strap through the strap lug, then secure it on the inside of the clasp.

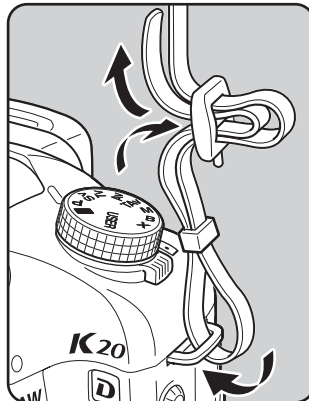

- 2** Pass the other end of the strap through the other strap lug on the camera, then secure it on the inside of the clasp.

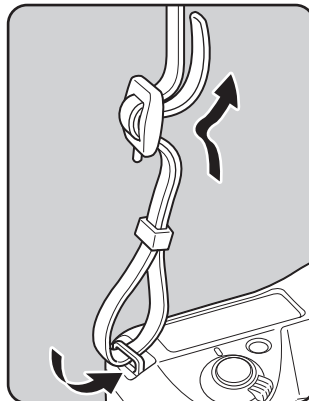

Using the Battery

Insert the battery into the camera. Use only a D-LI50 battery.

Charging the Battery

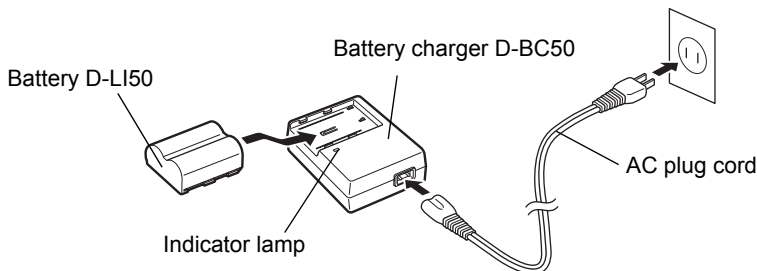

When using the battery for the first time, or when the battery has not been used in a long time, or when [Battery depleted] appears, recharge the battery.

Note: AC plug cord “Listed, Type SPT-2 or NISPT-2, 18/2 flexible cord, rated 125 V, 7A, minimum 6ft (1.8m)”

- 1** Connect the AC plug cord to the battery charger.
- 2** Plug the AC plug cord into the power outlet.
- 3** Face the ▲ mark on the exclusive battery up and insert it into the battery charger.
The indicator lamp is lit red during charging.
The indicator lamp turns off when the battery is fully charged.
- 4** When the battery is fully charged, remove the battery from the battery charger.



- Do not use the provided battery charger to charge batteries other than rechargeable lithium-ion battery D-LI50. Charging other batteries may cause damage or heating.
- If the battery is correctly oriented and inserted into the battery charger but the indicator lamp is not lit, the battery is faulty. Install a new battery in the camera.



- The maximum charging time is approximately 180 minutes. Charge in a location where the temperature is between 0°C and 40°C. (Charge time depends on temperature and remaining battery power.)
- If usage time is reduced even when properly charged, the battery has reached the end of its usage span. Install a new battery in the camera.

Inserting/Removing the Battery

When using the battery for the first time, charge the battery and insert it into the camera.



- Do not open the battery cover or remove the battery while the power is on.
- Remove the battery when you will not use the camera for a long while. The battery may leak.
- If the date and time settings have been reset when you insert a new battery after a long time, follow the procedure for “Setting the Date and Time”. (p.48)
- Insert the battery correctly. If the battery is inserted incorrectly, it may cause camera breakdown. Wipe the electrodes of the battery with a soft dry cloth before inserting.
- Be careful as the camera or battery may become hot when the camera is used continuously for a long period of time.

1 Open the battery cover.

Lift the battery cover unlock lever, turn towards OPEN (①) to unlock, and then pull the cover open (②).

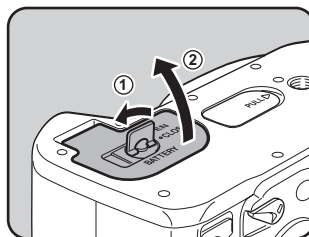

2 Face the ▲ mark on the battery towards the monitor, push the battery lock lever in the direction of the arrow (①) and insert the battery.

Insert until the battery locks.

To remove the battery, push the battery lock lever in the direction of the arrow (①) with your hand. The battery pops out slightly. Remove it.

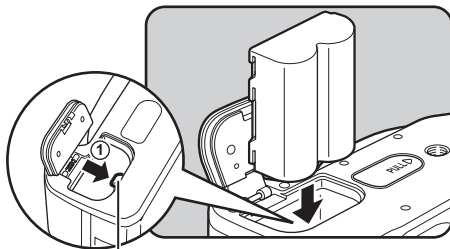

Battery lock lever

3 Close the battery cover (①) and turn the battery cover unlock lever towards CLOSE (②) to lock.



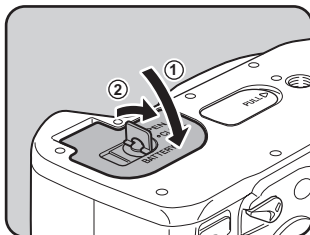

Stow the battery cover unlock lever when finished closing.





Use the AC adapter D-AC50 (optional) when using the camera for a prolonged period. (p.39)

Battery Level Indicator

You can confirm remaining battery level by checking the  displayed on the LCD panel.

	lit	: Battery is full.
↓		
	lit	: Battery is running low.
↓		
	lit	: Battery is almost empty.
↓		
	blink	: The camera turns off after displaying a message.



-  may appear even when the battery level is sufficient if the camera is used at low temperatures or when performing continuous shooting consecutively. Turn the camera off and on again. If  appears, you can use the camera.
-  does not appear on the LCD panel when using the AC adapter.

Approximate Image Storage Capacity and Playback Time (Exclusive Battery Fully Charged)

Battery	(Temperature)	Normal recording	Flash photography		Playback time
			50% use	100% use	
D-LI50	(23°C)	740	530	420	330 minutes
	(0°C)	700	430	320	300 minutes

The picture storage capacity (flash use 50%) is based on measuring conditions in accordance with CIPA standards and the others are based on PENTAX measuring conditions. Some deviation from the above figures may occur in actual use depending on shooting mode and shooting conditions.



- Battery performance temporarily decreases as the temperature decreases. When using the camera in cold climates, have extra batteries on hand and keep them warm in your pocket. Battery performance will return to normal when returned to room temperature.
- Have extra batteries ready when traveling overseas, taking pictures in cold climates, or when you will be taking a lot of pictures.
- If usage time is reduced even when properly charged, the battery has reached the end of its usage span. Install a new battery in the camera.

Using the AC Adapter (Optional)

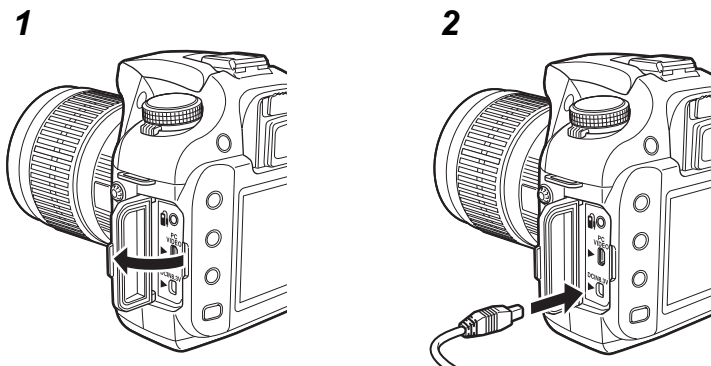

We recommend using the AC adapter D-AC50 (optional) when using the monitor for a long time or when connecting to your PC.

- 1** Make sure the camera is turned off and open the terminal cover.
- 2** Face the ▲ mark on the DC terminal of the AC adapter towards the ▲ mark on the camera, and connect the DC terminal to the DC input terminal of the camera.
- 3** Connect the AC plug cord to the AC adapter.
- 4** Plug the AC cord into the power outlet.



- Make sure the camera is turned off before connecting or disconnecting the AC adapter.
- Make sure connections are secure between the camera, AC adapter, AC plug cord terminal and the power outlet. SD Memory Card and data will be corrupted if disconnected while camera is recording or reading data.



- Be sure to read the AC adapter D-AC50 operating manual when using the AC adapter.
- The battery in your camera will not charge when connected to the AC adapter.

Inserting/Removing the SD Memory Card

This camera uses either an SD Memory Card or an SDHC Memory Card. (Both cards are referred to as SD Memory Cards hereafter.) Make sure the camera is turned off before inserting or removing the SD Memory Card (market product).



- Do not remove the SD Memory Card while the card access lamp is lit.
- Use this camera to format (initialize) an SD Memory Card that is unused or has been used on other cameras or digital devices. Refer to "Formatting the SD Memory Card" (p.218) for details on formatting.

2

Getting Started

1 Lift the card cover unlock lever (1) and turn it towards OPEN (2).

The card cover opens.

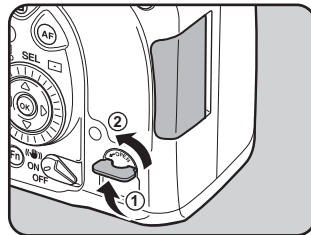

2 Insert the card all the way with the SD Memory Card label toward the monitor.

Push the SD Memory Card in once to remove.

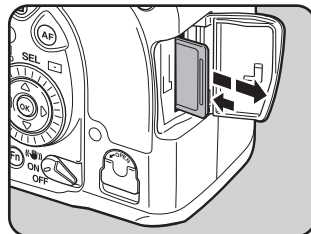
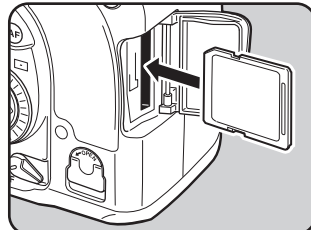

3 Close the card cover.



Be sure to fully close the card cover. The camera will not turn on if the card cover is open.

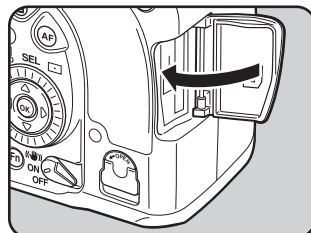

Precautions When Using the SD Memory Card

- The SD Memory Card is equipped with a write-protect switch. Setting the switch to LOCK protects the existing data by prohibiting recording of new data, deletion of existing data or formatting of the card.
 - Care should be taken when removing the SD Memory Card immediately after using the camera because the card may be hot.
 - Do not remove the SD Memory Card or turn the camera off while data is being saved to the card, images are being played back, or the camera is connected to a computer with the USB cable. This may cause the data to be lost or the card to be damaged.
 - Do not bend the SD Memory Card or subject it to violent impact. Keep it away from water and store away from high temperatures.
 - Do not remove the SD Memory Card during formatting. The card may be damaged beyond use.
 - Data on the SD Memory Card may be deleted in the following circumstances. PENTAX does not accept any liability for data that is deleted if
 - (1) the SD Memory Card is mishandled by the user.
 - (2) the SD Memory Card is exposed to static electricity or electrical interference.
 - (3) the card has not been used for a long time.
 - (4) the card is ejected or the battery is removed while the data on the card is being recorded or accessed.
 - The SD Memory Card has a limited service life. If it is not used for a long time, the data on the card may become unreadable. Be sure to regularly make a backup of important data on a computer.
 - Avoid using or storing the card where it may be exposed to static electricity or electrical interference.
 - Avoid using or storing the card in direct sunlight or where it may be exposed to rapid changes in temperature or to condensation.
 - For information on compatible SD Memory Cards, visit the PENTAX website.
 - Format new SD Memory Cards. Also format SD Memory Cards used with other cameras.  Formatting the SD Memory Card (p.218)
 - Please note that formatting the SD Memory Card will not necessarily delete the data so that it cannot be recovered using off the shelf data recovery software. If you are going to discard, give away or sell your SD Memory Card you should ensure that the data on the card is completely deleted or the card itself is destroyed if it contains any personal or sensitive information. There are off the shelf secure data deletion software programs available that will completely delete the data.
- In any case the data on your SD Memory Card should be managed at your own risk.

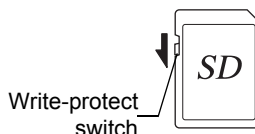

Recorded Pixels and Quality Level

When the File Format is JPEG

Choose the number of pixels (size) and quality level (JPEG data compression rate) of pictures according to how you intend to use the pictures you have taken.

Pictures with larger recorded pixels or more ★s are clearer when printed. The number of pictures that can be taken (the number of pictures that can be recorded on an SD Memory Card) decreases with larger file sizes. The quality of the captured photo or printed picture depends on the quality level, exposure control, resolution of the printer and a variety of other factors so you do not need to select more than the required number of pixels. For example, to print in postcard size, **2M** (1824×1216) is adequate. Set the appropriate recorded size and quality level depending on purpose.

Choose the appropriate number of recorded pixels and quality level for JPEG images on the [ Rec. Mode] menu.

- ☞ Setting the JPEG Recorded Pixels (p.156)
- ☞ Setting the JPEG Quality Level (p.157)

● JPEG Recorded Pixels, JPEG Quality and Approximate Image Storage Capacity

JPEG Quality \ JPEG Rec. Pixels	★★★★ Premium	★★★ Best	★★ Better	★ Good
14.6M (4672×3104)	34	58	105	205
10M (3872×2592)	50	84	148	308
6M (3008×2000)	88	142	245	457
2M (1824×1216)	230	368	616	1118

- The above table shows the approximate image storage capacity when using a 512 MB SD Memory Card.
- The above figures may vary depending on the subject, shooting conditions, shooting mode and SD Memory Card, etc.



When the number of storable images exceeds 500, captured images are divided into folders of 500 images each. However, in Auto Bracket, images will be stored in the same folder until shooting is completed, even if the number of images exceeds 500.

When the File Format is RAW

With **K20D**, you can record in the versatile JPEG format or the high quality and editable RAW format. For RAW file format, you can select the PENTAX original PEF format or general-purpose DNG (Digital Negative) format designed by Adobe Systems. On a 512 MB SD Memory Card, you can record up to 20 images in PEF format or DNG format.

☞ Setting the File Format (p.158)

Turning the Camera On and Off

1 Move the main switch to [ON] position.

The camera will turn on.

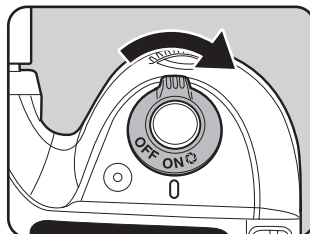

Move the main switch to [OFF] position to turn off the camera.



2

Getting Started



- Always turn the camera off when not in use.
- The power will automatically turn off when you do not perform any operations within a set period of time. To reactivate the camera after the camera turns off automatically, turn it on again or perform any of the following.
 - Press the shutter release button halfway.
 - Press the  button.
 - Press the **INFO** button.
- By default, the camera is set to power off automatically after 1 minute of inactivity. You can change the setting with [Auto Power Off] on the [ Set-up] menu. (p.233)

Initial Settings

The first time the camera is turned on after purchasing, the [Language/言語] screen appears on the monitor. Follow the procedure below to set the language displayed on the monitor and the current date and time. Once setting is done, these will not need to be set again when turning your camera on.

If the Date Adjust screen appears, set the date and time by following the procedure in "Setting the Date and Time" (p.48).

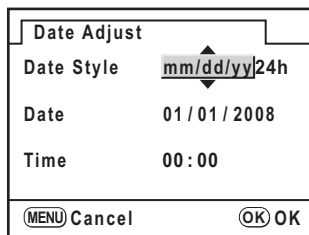

2

Getting Started

Setting the Display Language

You can choose the language in which the menus, error messages, etc. are displayed from the following: English, French, German, Spanish, Portuguese, Italian, Dutch, Danish, Swedish, Finnish, Polish, Czech, Hungarian, Turkish, Russian, Korean, Chinese (traditional/simplified) and Japanese.

1 Use the four-way controller (▲▼◀▶) to select the desired language.

The default setting is English.



2 Press the OK button.

The [Initial Setting] screen for the selected language appears.
Press the four-way controller (▼) twice and proceed to Step 9 if [Hometown] does not have to be adjusted.

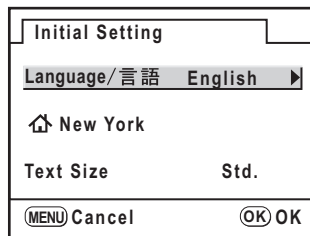
**3 Press the four-way controller (▼).**

The cursor moves to ⤴.

4 Press the four-way controller (▶) and use the four-way controller (◀▶) to select the city.**5 Press the four-way controller (▼).**

The cursor moves to DST (daylight saving time).

6 Use the four-way controller (◀▶) to select (On) or (Off).**7 Press the OK button.**

The camera returns to the [Initial Setting] screen.

8 Press the four-way controller (▼).

The cursor moves to [Text Size].

9 Press the four-way controller (▶) and use the four-way controller (▲▼) to select [Std.] or [Large].

Selecting [Large] magnifies the selected menu item.

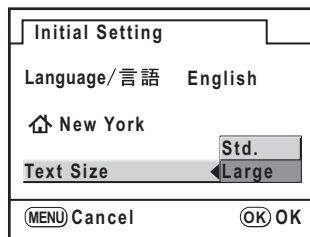
**10 Press the OK button twice.**

The screen for setting the date and time will be displayed.



In this manual, the menu screens hereafter are described with [Text Size] set to [Std.].

When an Incorrect Language is Set

When you mistakenly select a language in the [Language/言語] screen, you can perform the following operations to set the correct language.

1 Press the MENU button once or twice to display the guides (p.22) on the monitor.

The screen shown on the right is an example of the guides displayed. The displayed screen will vary depending on the selected language.

The guides appear on the monitor for 3 seconds. (Capture mode)

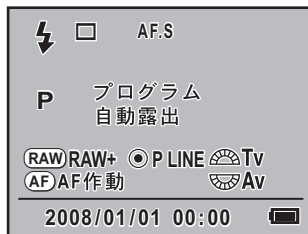

2 Press the MENU button once.

is displayed in the upper tab. ([Rec. Mode] menu)

3 Press the four-way controller (▶) twice.

is displayed in the upper tab. ([Set-up] menu)

4 Use the four-way controller (▼) to select [Language/言語] in the bottom row.

5 Press the four-way controller (▶).

The [Language/言語] screen appears.

6 Use the four-way controller (▲▼◀▶) to select the desired language and press the OK button.

The [Set-up] menu for the selected language appears.

Refer to the following pages and set the desired city for [Hometown] and the current date and time as necessary.

- To change Hometown: "Setting the World Time" (p.221)
- To change date and time: "Changing the Date and Time and the Display Style" (p.220)



When [Hometown] and the date and time are not set, the [Initial Setting] or [Date Adjust] screen will be displayed when the camera is turned on again.

Setting the Date and Time

Set the current date and time and the display style.

- 1 Press the four-way controller (▶).

The frame moves to [mm/dd/yy].

Date Adjust	
Date Style	mm/dd/yy 24h
Date	01 / 01 / 2008
Time	00 : 00
MENU Cancel OK OK	

- 2 Use the four-way controller (▲ ▼) to choose the date style.

- 3 Press the four-way controller (▶).

The frame moves to [24h].

Date Adjust	
Date Style	mm/dd/yy 24h
Date	01 / 01 / 2008
Time	00 : 00
MENU Cancel OK OK	

- 4 Use the four-way controller (▲ ▼) to select 24h (24-hour display) or 12h (12-hour display).

- 5 Press the four-way controller (▶).

The frame returns to [Date Style].

- 6 Press the four-way controller (▼).

The frame moves to [Date].

7 Press the four-way controller (▶).

The frame moves to the month.

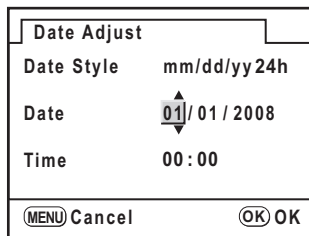

8 Use the four-way controller (▲▼) to set the month.

Set the day and year in the same manner.

Next, set the time.

If you select [12h] in Step 4, the setting switches between am and pm depending on the time.

9 Press the OK button.

The camera is ready to take a picture. If you set the date and time with the menu operations, the screen will return to the [🔍 Set-up] menu. Press the **OK** button again.



Pressing the **MENU** button while adjusting the date cancels the settings made so far and switches the camera to Capture mode. If the power is turned on without the date and time set, the Date Adjust screen is displayed if Initial Setting has been performed. You can also set the date later by menu operations. (p.220)



- When you finish the settings and press the **OK** button, the camera clock is reset to 00 seconds. To set the exact time, press the **OK** button when the time signal (on the TV, radio, etc.) reaches 00 seconds.
- You can change the language and date and time settings with the menu operations. (p.220, p.224)

Attaching the Lens

All camera exposure modes are available when using DA, D FA, FA J or other lenses with an Aperture **A** (Auto) position. Some functions are restricted when lenses are not set to the Aperture **A** position. Also see “Notes on [36. Using Aperture Ring]” (p.251). Other lenses and accessories will not be available with factory default settings. To allow shutter release with lenses or accessories not listed above, set [36. Using aperture ring] in the [**C** Custom Settings] menu. (p.75)



Turn the camera off before attaching or removing the lens to prevent unexpected lens movement.

2

Getting Started

1 Check that the camera is turned off.

2 Remove the body mount cover (①) and lens mount cover (②).

Be sure to put the lens down with the lens mount side facing up to protect the lens mount from damage after removal.

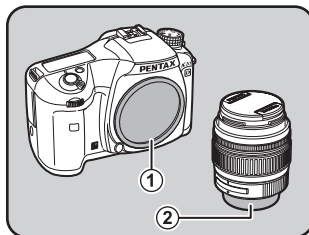

3 Align the red dots on the camera and the lens, and secure by turning the lens clockwise until it clicks.

After attaching, turn the lens counterclockwise to check that the lens is locked in place.

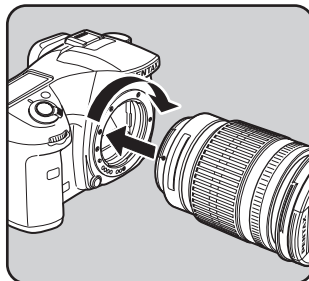

4 Remove the front lens cap by pushing the indicated portions inward.

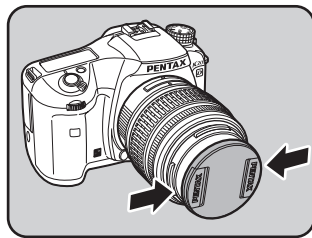

To detach the lens, hold down the lens unlock button (3) and turn the lens counterclockwise.

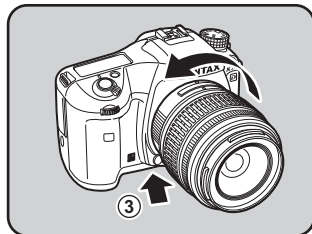

- The body mount cover (1) is a cover to prevent scratches and block dust when shipped. Body Mount Cap K is sold separately and has a lock function.
- We assume no responsibility nor liability for accidents, damages and malfunctions resulting from the use of lenses made by other manufacturers.
- The camera body and lens mount incorporate lens information contacts and an AF coupler. Dirt, dust, or corrosion may damage the electrical system. When necessary, clean the contacts with a soft dry cloth.

Adjusting the Viewfinder Diopter

Adjust the viewfinder to suit your eyesight.

If it is difficult to see the viewfinder image clearly, slide the diopter adjustment lever sideways.

You can adjust the diopter from approximately -2.5m^{-1} to $+1.5\text{m}^{-1}$.

2

Getting Started

- 1** Look through the viewfinder and point the camera at a white wall or other bright and consistent surface. Slide the diopter adjustment lever left or right.

Adjust the lever until the AF frame in the viewfinder is focused.

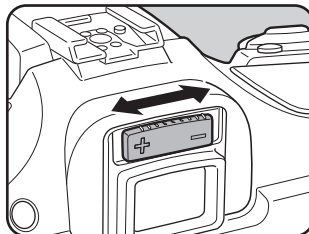

AF frame



- The F_P Eyecup is attached to the viewfinder portion when camera leaves the factory. Diopter adjustment is available with the F_P Eyecup attached. However, adjustment is easier with the eyecup removed. To remove the F_P Eyecup, press in one side and pull it out in the direction of the arrow.

To attach the F_P Eyecup, align it with the groove on the viewfinder eyepiece and push it into position.

- If it is difficult to see the viewfinder image clearly even if you set the diopter adjustment lever, use the diopter correction lens adapter M. However, the eyecup must be removed to use this adapter. (p.258)

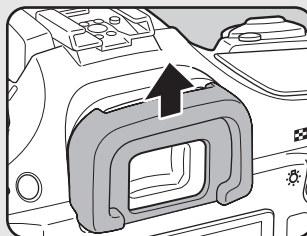

3 Basic Operations

This chapter explains basic operations for shooting by setting mode dial to Green mode (automatic exposure according to the Normal program line) to ensure successful capturing.

For information about advanced functions and settings for taking pictures, refer to chapter 4 and onward.

Basic Shooting Operation	54
Using a Zoom Lens	59
Using the Built-in Flash	60
Taking Pictures Using the Shake Reduction Function	65
Playing Back Still Pictures	68
Deleting Images	70

Basic Shooting Operation

Holding the Camera

How you hold the camera is important when taking pictures.

- Hold the camera firmly with both hands.
- Press the shutter release button gently when taking a picture.

3

Basic Operations

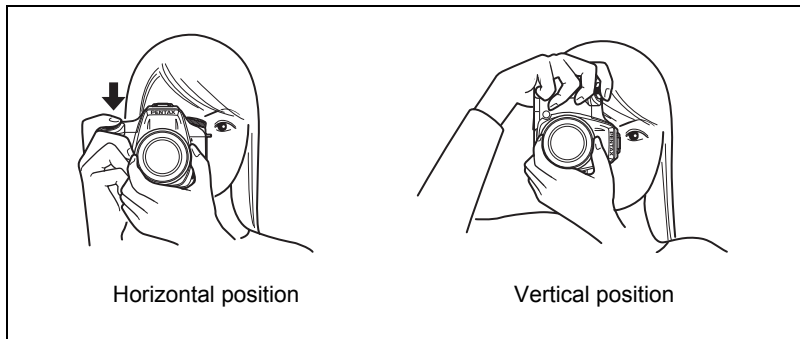

- To reduce camera shake, support your body or the camera on a solid object such as a table, tree, or wall.
- Although there are individual differences among photographers, the shutter speed for a handheld camera is generally $1/(\text{focal length} \times 1.5)$. For example, it is $1/75$ of a second for a focal length of 50 mm and $1/150$ of a second for 100 mm. Use a tripod or the Shake Reduction function (p.65) when using a lower shutter speed.
- When using a telephoto lens, a tripod that is heavier than the total weight of the camera and lens is recommended to avoid camera shake.
- Do not use the Shake Reduction function when using the camera on a tripod.

Letting the Camera Choose the Optimal Settings

The **K20D** features various Capture modes, Focus modes, and Drive modes suited for your intentions. This section explains how to take pictures by simply pressing the shutter release button.

1 Set the mode dial to **■**.

The Exposure mode changes to **■** (Green) mode. In **■**, proper exposure is determined by the camera and the shutter speed and aperture are automatically set. (p.83)

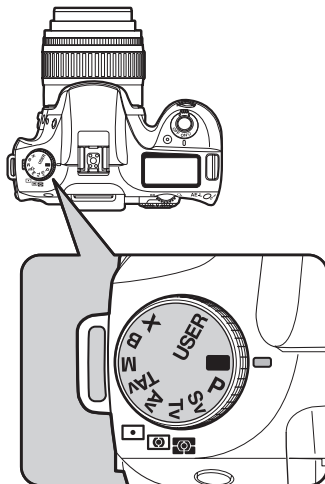

2 Set the focus mode lever to **A.F.S.**

The Focus mode changes to **A.F.S** (Autofocus/Single) mode. In **A.F.S**, the lens automatically focuses when the shutter release button is pressed halfway. When the image is focused, the shutter can be released. (p.104)

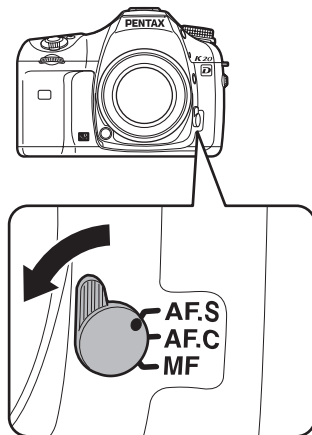

3 Look through the viewfinder to view the subject.

A zoom lens can be used to change the size of the subject in the viewfinder.

☞ Using a Zoom Lens (p.59)

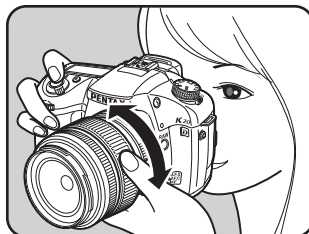

4 Position the subject inside the AF frame and press the shutter release button halfway.

The autofocus system operates. The focus indicator ● appears in the viewfinder when the subject comes into focus.

The flash does not pop up automatically. If the flash is necessary, the flash status ⚡ blinks. Press the ⚡UP button (p.63) to pop up the flash manually.

☞ Operating the shutter release button (p.57)

☞ Subjects that are Difficult to Focus on (p.58)

☞ Using the Built-in Flash (p.60)

☞ Selecting the Focusing Area (AF Point) (p.107)



Flash status

Focus indicator status



You can preview the image in the monitor and check the composition, exposure, and focus before taking the picture. (p.113)

5 Press the shutter release button fully.

The picture is taken.





6 Review the captured image on the monitor.

Image appears for 1 second on the monitor after capturing (Instant Review).

You can magnify the image during Instant Review with the rear e-dial. (p.174)

You can delete the image during Instant Review by pressing the  button.

-  Setting the Instant Review (p.227)
-  Deleting Images (p.70)
-  Bright/Dark Area Display (p.227)
-  Histogram Display (p.227)

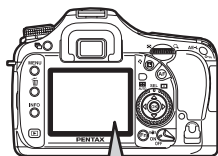

Operating the shutter release button

The shutter release button has two working positions.

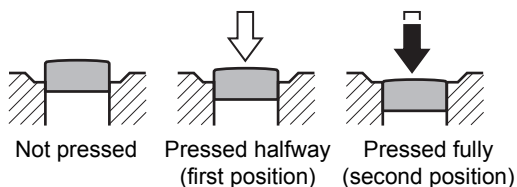

Pressing it down halfway (first position) turns on the viewfinder and LCD panel indicators and the autofocus system operates. Pressing it fully (second position) takes the picture.



- Press the shutter release button gently when taking a picture to prevent camera shake.
- Practice pressing the shutter release button halfway to learn where the first position is.
- The viewfinder indicators stay on while shutter release button is pressed halfway. The indications stay on for about 10 seconds (default setting) while the exposure metering timer is on after the button is released. (p.27, p.99)

Subjects that are Difficult to Focus on

The autofocus mechanism is not perfect. Focusing may be difficult when taking pictures under the following conditions ((a) to (f) below). These also apply to manual focusing using the focus indicator  in the viewfinder. If the subject cannot be focused automatically, set the focus mode lever to **MF** and use the manual focus mode to focus on the subject with the aid of the matte field in the viewfinder. (p.111)

- (a) Extremely low-contrast subjects such as a white wall in the focusing area.
- (b) Subjects which do not reflect much light within the focusing area.
- (c) Fast moving objects.
- (d) Strongly reflected light or strong backlighting (bright background).
- (e) If repeating vertical or horizontal line patterns appear within the focusing area.
- (f) Multiple subjects in the foreground and background within the focusing area.



Subject may not be focused even when  (focus indicator) is displayed when (e) and (f) above apply.

Using a Zoom Lens

Enlarge the subject (telephoto) or capture a wider area (wide angle) with a zoom lens. Adjust it to the desired size and take the picture.

1 Turn the zoom ring to the right or left.

Turn the zoom ring clockwise for telephoto and counterclockwise for wide angle.

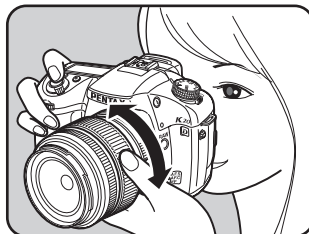

- The smaller the number of the displayed focal length, the wider the angle. The larger the number, the more magnified the image appears.
- Power Zoom (Auto Zoom) is available if a Power Zoom compatible FA lens is used with this camera.

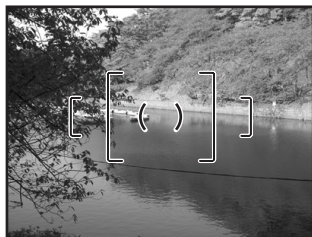

Wide Angle

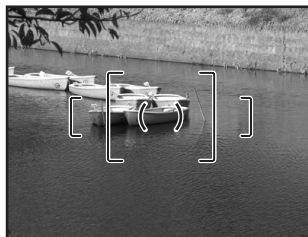

Telephoto

Using the Built-in Flash

If you wish to discharge the flash in a dark or backlit location, press the **⚡UP** button to pop up the flash. Select a flash mode to suit your purpose from the Flash options screen in the Fn menu. You can adjust the flash output with the rear e-dial in any Exposure mode other than Green mode. The built-in flash is optimum at about 0.7 m to 5 m from the subject. Exposure will not be properly controlled and vignetting may occur when used at a distance closer than 0.7 m (this distance varies slightly depending on the lens being used and set sensitivity (p.141)).

3

Basic Operations









Compatibility of built-in flash and lens

Vignetting (darkening of the corners of the image due to a lack of light) may occur depending on the lens being used and the capture conditions. We recommend taking a test shot to confirm this.

☞ DA, D FA, FA J, FA and F Lens Compatibility with the Built-in Flash (p.142)



- When using the built-in flash, remove the lens hood before shooting.
- The built-in flash fully discharges for lenses without a function to set aperture lens ring to **A** (Auto).

 Auto discharge	Discharges the flash automatically in dark or backlit locations.
 Auto flash+ Redeye reduct	Lights a red-eye reduction light before automatic flash.
 Flash On	Discharges the flash each time.
 Flash On+ Red-eye	Lights a red-eye reduction light before discharging the flash with Flash On.
 Slow-speed sync	Sets the shutter speed slower depending on the brightness. Use this when shooting a portrait in front of a sunset or other scenery to capture both the person and background clearly.
 Slow-speed sync+ Red-eye	Lights a red-eye reduction light before discharging the flash with Slow-speed sync.
 Trailing curtain sync	Discharges flash immediately before closing the shutter curtain. Capture moving images as if they are leaving a trail behind.
 Wireless Mode	You can synchronize a dedicated external flash (AF540FGZ or AF360FGZ) without using a sync cord.



When using Slow-speed sync or Slow-speed sync+Red-eye, the shutter speed becomes slower depending on the brightness. Use Shake Reduction (p.65) or fix the camera on a tripod to prevent camera shake.

Selecting Flash Mode

1 Press the Fn button.

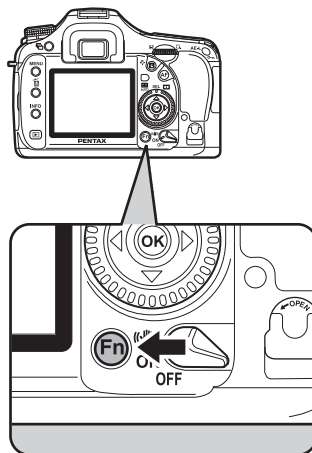

The Fn menu appears.

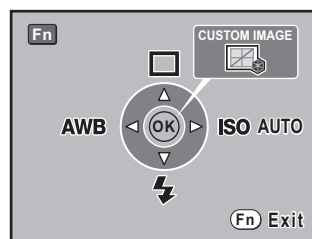

2 Press the four-way controller (▼).

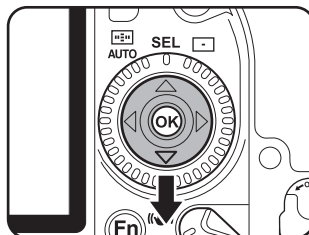

The Flash options screen appears.

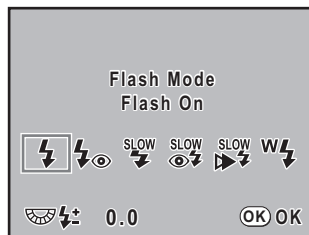

- When the mode dial is set to **M**, ⚡^{\wedge} and ⚡° can be selected, when set to **Tv**, **TAv**, **M** or **B**, you can select ⚡ , ⚡° , ⚡^{SLOW} and ⚡^{W} , and when set to **X**, you can select ⚡ , ⚡° and ⚡^{W} . For any other mode, ⚡ , ⚡° , ⚡^{SLOW} , ⚡^{SLOW} , ⚡^{SLOW} and ⚡^{W} can be selected.
- When the mode dial is set to **USER**, the available flash modes vary depending on the settings that have been saved.

3 Use the four-way controller (◀▶) to choose a flash mode.

When not in **M** (Green) mode, turn the rear e-dial to perform Flash exposure compensation. (p.136)

4 Press the OK button.

The camera is ready to take a picture.

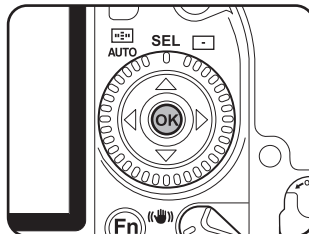

Using Built-in Flash

1 Press the **⚡UP** button.

The built-in flash pops up and begins charging. When the flash is fully charged, **⚡** appears in the LCD panel and viewfinder.
(p.27, p.29)

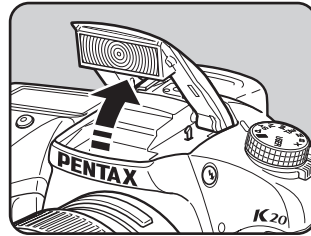
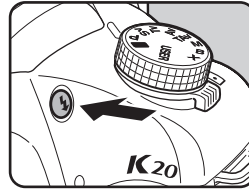

2 Press the shutter release button halfway.

The focus indicator **●** appears in the viewfinder when focused.

3 Press the shutter release button fully.

The picture is taken.



- When the mode dial is at **■**, the flash is not discharged when the lighting conditions do not require flash for correction even if the flash is popped up.
- The Flash On is used when the flash is popped up if the mode dial is at a setting other than **■**.

4 Push down on the portion indicated in the illustration to retract the flash.

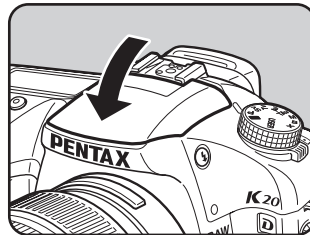



Using Red-eye Reduction Flash

“Red-eye” is the phenomenon where eyes look reddish in photographs taken in dark environments with a flash. This is caused by the reflection of the electronic flash in the retina of the eye. Red-eye occurs because pupils are dilated in dark environments.

This phenomenon cannot be averted but the following measures can be used to combat it.

- Brighten the surroundings when shooting.
- Set to wide angle and shoot from closer if a zoom lens is in use.
- Use a flash that supports red-eye reduction.
- Position the flash as far away from the camera as possible when using an external flash.

The red-eye reduction function on this camera reduces red-eye by discharging the flash twice. With the red-eye reduction function, the pre-flash is discharged just before the shutter is released. This reduces pupil dilation. The main flash is then discharged while the pupils are smaller, reducing the red-eye effect. To use the red-eye reduction function, set  (Auto flash+Redeye reduct) in Green mode, or  (Flash On+Red-eye) or  (Slow-speed sync+Red-eye) in other modes for Flash mode.

Daylight-Sync Shooting

In daylight conditions, the flash will eliminate shadows when a portrait picture is taken with a person's face cast in shadow. Use of the flash in this way is called Daylight-Sync Shooting. Flash On is used when shooting with Daylight-Sync Shooting.

● Taking pictures (Hyper-program)

- 1 Pop up the flash manually and confirm that the flash mode is set to  (Flash On). (p.63)
- 2 Confirm that the flash is fully charged.
- 3 Take the picture.



The picture may be overexposed if the background is too bright.



Without Daylight-Sync



With Daylight-Sync

Taking Pictures Using the Shake Reduction Function

You can easily take sharp pictures using the Shake Reduction function by simply turning on the Shake Reduction switch.

Shake Reduction

The Shake Reduction function reduces camera shake that occurs when the shutter release button is pressed. This is useful for taking pictures in situations where camera shake is likely to occur. The Shake Reduction function allows you to take pictures at approximately 4 steps slower shutter speed without the risk of the camera shake.

The Shake Reduction function is ideal when taking pictures in the following situations.

- When taking pictures in dimly lit locations, such as indoors, at night, on cloudy days and in the shade
- When taking telephoto pictures

Blurred picture

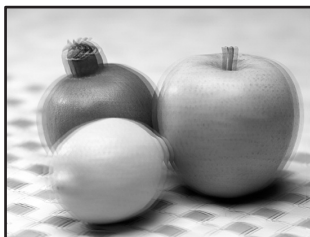

Picture taken with the Shake Reduction function



Caution:

- The Shake Reduction function does not compensate for blurring caused by movement of the subject. To take pictures of a moving subject, increase the shutter speed.
- The Shake Reduction function may not fully reduce camera shake when taking close-up shots. In this case, it is recommended that the Shake Reduction function be turned off and the camera be used with a tripod.
- The Shake Reduction function will not fully work when shooting with a slower shutter speed, for example when shooting a moving subject or night scenes. In this case, it is recommended that the Shake Reduction function be turned off and the camera be used with a tripod.

Shake Reduction Function and Lens Focal Length

The Shake Reduction function operates by acquiring the lens information such as focal length.

If the camera uses a DA, D FA, FA J, FA or F lens, the lens information is automatically acquired when the Shake Reduction function is activated.

[Focal Length] cannot be set from [Input Focal Length] menu in the [CAMERA] Rec. Mode] (The menu items cannot be selected).

If another type of lens is used, the lens information cannot be automatically acquired even when the Shake Reduction function is activated.

In this case, the [Input Focal Length] setting menu appears. Set [Focal Length] manually on the [Input Focal Length] setting menu. Setting the Shake Reduction Function (p.67)

Turning On the Shake Reduction Function

1 Turn on the Shake Reduction switch.

When the shutter release button is pressed halfway, (☞) appears in the viewfinder and the Shake Reduction function turns on.

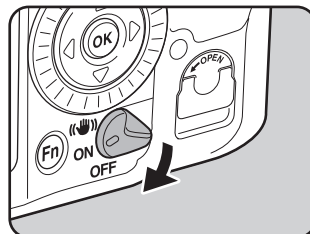

3

Basic Operations



- Be sure to turn off the Shake Reduction switch when using the camera with a tripod.
- The Shake Reduction function automatically turns off in the following situations.
When using self-timer, 2 sec. self-timer, remote control shooting, 3 sec. delay shooting, bulb shooting, or wireless mode with an external flash



- If a type of lens that does not support automatic acquisition of lens information such as focal length is used (p.65), the [Input Focal Length] menu appears. Set [Focal Length] manually on the [Input Focal Length] setting menu. Setting the Shake Reduction Function (p.67)
- Turn the Shake Reduction switch off if you will not use the Shake Reduction function.
- The Shake Reduction function will not fully work (for about 2 seconds) right after turning on the camera or restoring from Auto Power Off. Wait for the Shake Reduction function to become stable before gently pressing the shutter release button to take a picture. Press the shutter release button halfway. The camera is ready to take pictures when (☞) appears in the viewfinder.
- Shake Reduction is available with any **K20D** compatible PENTAX lens. However, when the aperture ring is set at other than the **A** (Auto) position or a lens without an **A** position is used, the camera does not operate unless [36. Using aperture ring] is set to [Permitted] in the [**C** Custom Setting] menu (see p.75; see p.30 - p.31 for operation method). Set this beforehand. Note that some functions are restricted when [36. Using aperture ring] is set to [Permitted] in the [**C** Custom Setting] menu. Refer to "Notes on [36. Using Aperture Ring]" (p.251) for details.

Setting the Shake Reduction Function

The [Input Focal Length] setting menu appears when the camera is turned on with the Shake Reduction switch on and a type of lens that does not support automatic acquisition of lens information such as focal length (p.65) is mounted.

Set [Focal Length] manually on the [Input Focal Length] setting menu.



- The [Input Focal Length] setting menu does not appear when using a lens that supports automatic acquisition of lens information such as focal length because [Focal Length] is set automatically.
- When using a lens without the **A** position on the aperture or with the aperture set to a position other than the **A** position, set [36. Using aperture ring] on the [**C** Custom Setting] menu to [Permitted].

1

Use the four-way controller (◀▶) or the rear e-dial to set [Focal Length].

Select from the following 34 focal length values. (The default setting is 35.)

8	10	12	15	18	20	24	28	30	35
40	45	50	55	65	70	75	85	100	120
135	150	180	200	250	300	350	400	450	500
550	600	700	800						

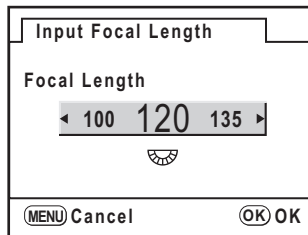

- If the focal length for your lens is not listed above, select the value closest to the actual focal length (example: [18] for 17 mm and [100] for 105 mm).
- When using a zoom lens, select the actual focal length at the zoom setting in the same manner.
- Effect of Shake Reduction is influenced by the shooting distance as well as focal length information. The Shake Reduction function may not perform as expected when shooting at close ranges.

2

Press the OK button.

The camera is ready to take a picture.



To change the [Focal Length] setting, use [Input Focal Length] on the [📷 Rec. Mode] menu. (p.72)

Playing Back Still Pictures

Playing Back Images

You can play back captured still pictures with the camera.



Use the included “PENTAX PHOTO Browser 3” software to play back using a PC. Refer to the “PENTAX PHOTO Browser 3/PENTAX PHOTO Laboratory 3 Operating Manual” for details.

3

Basic Operations

1 Press the button after taking a picture.

The most recently captured image (image with the largest file number) is displayed on the monitor.

Press the **INFO** button during playback to display information such as the image data for the displayed image.

Refer to p.25 - p.26 for display information details.

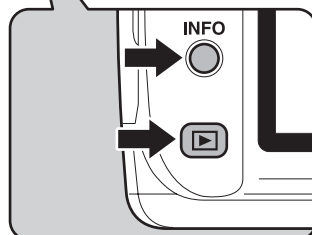
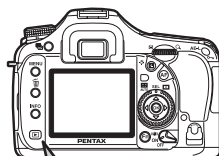

Standard display

INFO

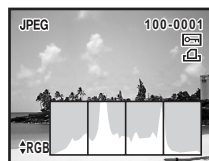

Histogram display



No info. Display

INFO



Detailed information display



2 Press the four-way controller (◀▶).

- ◀ : The previous image appears.
- ▶ : The next image appears.

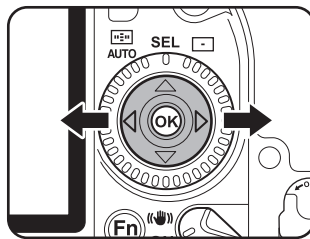

- You can display the next or previous image by turning the front e-dial.
- Refer to “Playback Functions” (p.169) for playback mode details.

Deleting Images

Deleting a Single Image

You can delete one image at a time.



- Deleted images cannot be restored.
- Protected images cannot be deleted.

3

Basic Operations

1 Press the button and use the four-way controller (◀▶) to select an image to delete.

2 Press the button.

The Delete screen appears.

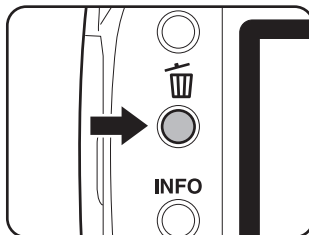

3 Use the four-way controller (▲▼) to select [Delete].

Select the file format to delete for images saved in RAW+ format.

Delete JPEG	Deletes only the JPEG image.
Delete RAW	Deletes only the RAW image.
Delete RAW+JPEG	Deletes both file formats.

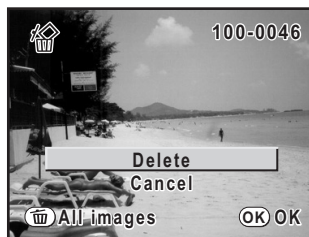

4 Press the OK button.

The image is deleted.



When deleting multiple images, refer to “Deleting Multiple Images” (p.185).

4 Shooting Functions

This chapter describes the various basic and advanced shooting functions available with the *K20D*.

How to Operate the Shooting Menus	72
Setting the Exposure	76
Focusing	104
Checking the Composition, Exposure and Focus Before Shooting	113
Continuous Shooting	117
Interval Shooting	120
Self-Timer Shooting	122
Remote Control Shooting (Remote Control F: Sold Separately)	125
Using Mirror Up Function to Prevent Camera Shake	128
Changing the Shooting Conditions Automatically when Shooting (Auto Bracket)	129
Storing User Settings	133

How to Operate the Shooting Menus

Press the **MENU** button in Capture mode. The [📷 Rec. Mode] menu appears.

[📷 Rec. Mode] Menu Setting Items

Perform settings related to capturing in the [📷 Rec. Mode] menu.

Item	Function	Page
Exposure Mode	Sets the Exposure mode. * Appears only when the mode dial is set to USER .	p.133
JPEG Recorded Pixels	Sets the recording size of images for JPEG shooting.	p.156
JPEG Quality	Sets the image quality for JPEG shooting.	p.157
File Format	Sets the file format.	p.158
RAW file format	Sets the file format for RAW shooting.	p.158
Extended Bracket	Sets Extended Bracket shooting.	p.131
Multi-exposure	Sets Multi-exposure shooting.	p.103
Interval Shooting	Sets interval shooting.	p.120
Color Space	Sets the color space to use.	p.167
RAW button	Sets the RAW button function.	p.159
Memory	Sets the settings to save when the power is turned off.	p.236
Input Focal Length	Sets the [Focal Length] when using a lens for which focal length information cannot be acquired.	p.67

[C Custom Setting] Menu Setting Items

Set custom functions to fully use the functions of a SLR camera with the Custom Setting Menu. The default setting does not change custom function.

The [C Custom Setting] menu settings are activated when [Setting], the first item, is (On).

Item	Function	Page
Setting	Sets to change custom function.	-
1. Program Line	Set the type of Program line.	p.82
2. EV Steps	Sets the adjustment steps for exposure.	p.101
3. Sensitivity Steps	Sets the adjustment steps for ISO sensitivity.	p.78
4. Expand sensitivity	Sets whether to increase the upper sensitivity limit to ISO 6400.	p.78
5. Meter Operating Time	Sets the exposure metering time.	p.99
6. AE-L with AF locked	Sets whether to lock exposure value when focus is locked.	p.110
7. Link AF Point and AE	Sets whether to link the exposure and AF point in the focusing area during multi-segment metering.	p.99
8. One-Push Bracketing	Sets whether to shoot all frames with one release when using Exposure Bracket.	p.130
9. Auto Bracketing order	Sets the order for bracket shooting.	p.129
10. Auto EV Compensation	Sets whether to compensate automatically when proper exposure cannot be determined.	-
11. WB when using flash	Sets whether to fix white balance when flash is discharged.	p.161
12. WB Adjustable Range	Sets whether to automatically fine-tune the white balance when specifying the light source on the White Balance setting.	p.161
13. AF Button Function	Sets the operation for when the AF button is pressed. When set to [Enable AF], AF is performed when the AF button is pressed. When set to [Cancel AF], AF is not performed when the shutter release button is pressed halfway while the AF button is pressed. When set to [Center AF Point] with SEL (Select) set on the AF point switching dial, the AF point is set to the center when the AF button is pressed.	p.107, p.112

Item	Function	Page
14. AF by Press Halfway	Sets whether to perform AF when the shutter release button is pressed halfway.	-
15. Superimpose AF Area	Sets whether to display the selected AF point (focus position) in the viewfinder.	p.107
16. AF in remote control	Sets whether to use Autofocus when shooting with remote control. Shutter releases after AF activates if shutter is released from remote control when set to [On]. Shutter cannot be released until in focus. AF does not activate at shutter release from remote control when set to [Off].	-
17. Slow Shutter Speed NR	Sets whether to allow the camera to select when to reduce noise or to reduce noise only when shooting at slow shutter speeds.	p.80
18. High-ISO Noise Reduction	Sets whether to use Noise Reduction when shooting with a high ISO. Select from three levels.	p.80
19. Color temp. steps	Sets the adjustment steps for color temperature.	p.165
20. e-dial in Program	Sets the e-dials in P (Hyper-program) mode.	-
21. e-dial in Sv mode	Sets the e-dials in Sv (Sensitivity Priority) mode.	-
22. e-dial in Tv mode	Sets the e-dials in Tv (Shutter Priority) mode.	-
23. e-dial in Av mode	Sets the e-dials in Av (Aperture Priority) mode.	-
24. e-dial in TA_v & M	Sets the e-dials in TA_v (Shutter and Aperture Priority) mode and M (Hyper-manual) mode.	-
25. e-dial in B & X	Sets the e-dials in B (Bulb) mode and X (Flash X-sync speed) mode.	-
26. Green button in TA_v & M	Selects the exposure adjustment method when the Green button is pressed in TA_v (Shutter and Aperture Priority) mode or M (Hyper-manual) mode.	p.95
27. Illuminate LCD panel	Sets whether to illuminate the LCD panel.	p.29
28. Release when Charging	Sets to release shutter while the built-in flash is charging.	p.137
29. Flash in Wireless Mode	Sets the built-in flash discharge method in wireless mode.	p.146
30. Preview Method	Sets Preview Method when the main switch is turned to the preview position (⊙).	p.113

Item	Function	Page
31. Display Sensitivity	Sets whether to switch the number of recordable images in the LCD panel and viewfinder to the sensitivity display.	-
34. Catch-in focus	When set to [On], if the focus mode is set to AFS and a manual focus lens is attached, catch-in focus shooting is possible and the shutter is released automatically when the subject comes into focus.	p.112
35. AF Adjustment	Performs AF adjustment.	p.106
36. Using aperture ring	Sets to enable shutter release when lens aperture ring is set at other than A .	p.251
Reset Custom Function	Resets all the settings in the Custom Setting menu to the defaults.	p.239

Shooting Fn Menu Setting Items

Press the **Fn** button in Capture mode. The Fn menu appears.

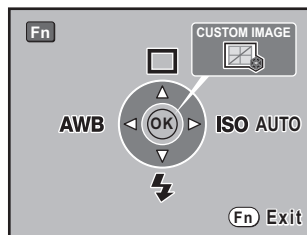

Press the four-way controller (**▲▼◀▶**) or the **OK** button to set the operation.

Key or Button	Item	Function	Page
▲	Drive Mode	Selects Continuous shooting, Self-timer or Remote control.	p.117, p.122, p.125
▼	Flash Mode	Adjusts the method of flash discharge.	p.61
◀	White Balance	Adjusts the color balance to match the type of the light source illuminating the subject.	p.160
▶	Sensitivity	Sets the sensitivity.	p.78
OK	Custom Image	Sets image processing.	p.154

Setting the Exposure

Effect of Aperture and Shutter Speed

Correct exposure of the subject is determined by the combination of shutter speed and aperture setting. There are many correct combinations of shutter speed and aperture for a particular subject. Different combinations produce different effects.

Effect of Shutter Speed

4

Shooting Functions

The shutter speed determines the length of time that light is allowed to strike the CMOS sensor.

- **Using slower shutter speed**

If the subject is moving, the image will be blurred because the shutter is open longer.

It is possible to enhance the effect of motion (rivers, waterfalls, waves, etc.) by intentionally using a slower shutter speed.

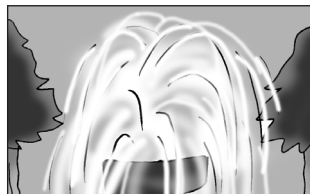

- **Using faster shutter speed**

Choosing a faster shutter speed will allow freezing the action of a moving subject. A faster shutter speed also helps preventing camera shake.

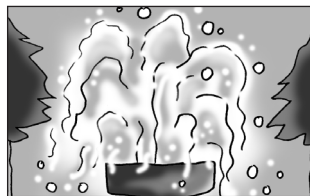

Effect of Aperture

Adjust the amount of light hitting the CMOS sensor by changing the aperture.

● Opening the aperture (reduce the aperture value)

Objects closer and farther than the focused subject will be more out of focus. For instance, if you take a picture of a flower against a landscape with the aperture open, the landscape in front and behind the flower will be blurred, emphasizing only the flower.



● Closing the aperture (increase the aperture value)

The range in focus expands forward and backward. For instance, if you take a picture of a flower against a landscape with the aperture narrowed, the landscape in front and behind the flower will be in focus.

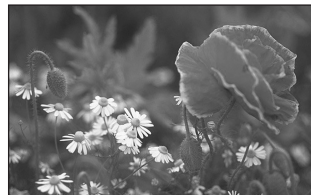

4

Shooting Functions

Depth of Field

When you focus on a portion of the subject, there is a range in which both objects closer and farther will also be in focus. This focused range is called the depth of field.

- The depth of field for the **K20D** differs depending on the lens but compared to a 35 mm camera, the value is roughly one aperture setting lower (the focused range becomes narrower).
- The wider the wide-angle lens, and the farther away the subject, the deeper the depth of field is (some zoom lenses do not have a scale for depth of field because of their designs).

Depth of field	Shallow	←————→	Deep
Area of focus	Narrow	←————→	Wide
Aperture	Open (Smaller value)	←————→	Close (Larger value)
Lens focal length	Longer (Telephoto)	←————→	Shorter (Wide-angle)
Distance to the subject	Near	←————→	Far

Setting the Sensitivity

You can set the sensitivity to suit the brightness of the surroundings. The sensitivity can be set to [AUTO] or within a sensitivity range equivalent to ISO 100 to 3200. The default setting is [AUTO]. Set [Sensitivity] in the Fn menu. (p.75)

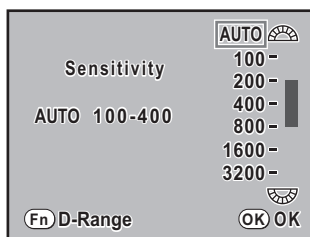

4

Shooting Functions



- [Sensitivity] in the Fn menu cannot be used to set the sensitivity when the exposure mode is set to **Sv** (Sensitivity Priority). Turn the rear e-dial in Capture mode to make the setting. (p.85)
- Settings other than [AUTO] are not available in [Sensitivity] when the exposure mode is set to **TAv** (Shutter & Aperture Priority).
- When the exposure mode is set to **B** (Bulb), the upper sensitivity limit is ISO 1600.
- The sensitivity range can be expanded to a range of ISO 100 to 6400 when [4. Expand sensitivity] in the [C Custom Setting] menu is set to [On].
- Noise Reduction is set to [Strong] when shooting with a sensitivity of ISO 3200 or higher, regardless of the [18. High-ISO Noise Reduction] setting (p.80) in the [C Custom Setting] menu.
- Captured images can show more noise if a higher sensitivity is set.
- You can set whether to lock the ISO sensitivity adjustment to increments of 1 EV or to coordinate it with the EV Steps (p.101) in [3. Sensitivity Steps] in the [C Custom Setting] menu.

Setting the Range of Automatic Correction in AUTO

Set range to automatically correct sensitivity when Sensitivity is set to [AUTO]. The sensitivity is automatically corrected in the range of [ISO 100-400] by default.

Turn the front or rear e-dial to set the range in [Sensitivity] in the Fn menu.

Front e-dial	Sets the lower sensitivity limit.
Rear e-dial	Sets the upper sensitivity limit.



When the exposure mode is set to **M** (Hyper-manual), **B** (Bulb) or **X** (Flash X-sync speed), the sensitivity cannot be set to [AUTO].

Changing the Sensitivity in Capture Mode

Press the **OK** button in Capture mode. The set sensitivity is displayed on the LCD panel and in the viewfinder. Turn the front e-dial while pressing the **OK** button to change the sensitivity.



- You can set the sensitivity to ISO AUTO by pressing the Green button while pressing the **OK** button when the exposure mode is set to **P** (Hyper-program), **Tv** (Shutter Priority), or **Av** (Aperture Priority).
- You can display the number of recordable images by pressing the **OK** button when the exposure mode is set to **Sv** (Sensitivity Priority) or **TAv** (Shutter and Aperture Priority).

Expanding the Dynamic Range

Dynamic range is the ratio that indicates the light level expressed by the CMOS sensor pixels from bright areas to dark areas.

By using the Expand Dynamic Range function, you can expand the light level expressed by the CMOS sensor pixels, making it more difficult for bright areas to occur in the image.

Press the **Fn** button for the [Sensitivity] setting in the Fn menu to turn this function on or off.

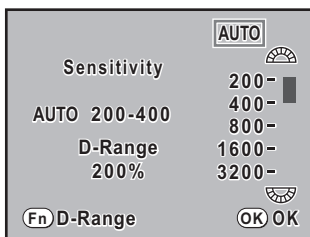

When the dynamic range is expanded, the sensitivity range is reduced to ISO 200 to 3200.

Noise Reduction

When you use a digital camera to shoot with a long exposure or high sensitivity setting, image noise (image roughness or unevenness) becomes noticeable.

You can reduce image noise by using Noise Reduction. Images shot with Noise Reduction take longer to save.

Set in [17. Slow Shutter Speed NR] or [18. High-ISO Noise Reduction] in the [C Custom Setting] menu.

● Slow Shutter Speed NR

Auto: The camera determines the conditions such as the shutter speed, sensitivity, and internal temperature, and automatically reduces noise as necessary.

On: Reduces noise only when shooting at slow shutter speeds (0.3 seconds or more).

● High-ISO Noise Reduction

Select the level of noise reduction from [Off], [Weakest], [Weak], or [Strong] when shooting with a high-sensitivity setting.

Changing the Exposure Mode

This camera features the following nine exposure modes.

Use the mode dial (p.32) to change the exposure mode. The settings available for each exposure mode are as follows.

Exposure Mode	Description	EV Compensation	Change Shutter Speed	Change Aperture	Sensitivity	Page
 (Green)	Automatically sets shutter speed and aperture to the proper exposure according to Program line when taking pictures.	No	No	No	Yes	p.83

Exposure Mode	Description	EV Compensation	Change Shutter Speed	Change Aperture	Sensitivity	Page
P (Hyper-program)	Automatically sets shutter speed and aperture to the proper exposure according to Program line when taking pictures. You can use the front and rear e-dials to easily switch between shutter priority and aperture priority.	Yes	Yes	Yes	Yes	p.84
Sv (Sensitivity Priority)	Automatically sets the shutter speed and aperture to the proper exposure according to the set sensitivity.	Yes	No	No	Other than Auto	p.85
Tv (Shutter Priority)	Lets you set the desired shutter speed for expressing moving subjects.	Yes	Yes	No	Yes	p.87
Av (Aperture Priority)	Lets you set aperture for controlling the depth of field.	Yes	No	Yes	Yes	p.89
TAv (Shutter & Aperture Priority)	Automatically sets the sensitivity so that the manually set shutter speed and aperture will give the proper exposure according to the brightness of the subject.	Yes	Yes	Yes	Auto only	p.91
M (Hyper-manual)	Lets you set shutter speed and aperture to capture the picture with creative intent.	Yes*	Yes	Yes	Other than Auto (up to ISO 1600)	p.93
B (Bulb)	Lets you capture images that require slow shutter speeds such as fireworks and night scenes.	No	No	Yes	Other than Auto	p.96

Exposure Mode	Description	EV Compensation	Change Shutter Speed	Change Aperture	Sensitivity	Page
X (Flash X-sync speed)	The shutter speed is locked at 1/180 seconds. Use this when using an External flash that does not automatically change the shutter speed.	Yes*	No	Yes	Other than Auto	p.97

* Refer to p.101 for details on EV compensation for **M** (Hyper-manual) and **X** (Flash X-sync speed).

About Program Line

In [1. Program Line] in the [**C** Custom Setting] menu, choose normal Program line or one of the following. In **■** and **P**, exposure is regulated according to the set Program line.

Normal	Normal program is the basic Program Automatic Exposure.
Hi Speed (Hi-speed priority)	Hi-speed priority program is a Program Automatic Exposure that prioritizes high shutter speeds.
Depth (Depth-of-field priority)	Depth-of-field priority program is a Program Automatic Exposure that prioritizes lower aperture.
MTF (MTF priority)	MTF priority program is a Program Automatic Exposure that prioritizes the best aperture settings for the attached lens and is effective when combined with a DA, D FA, FA, or FA J lens.

Using the **■** (Green) Mode

Automatically sets shutter speed and aperture to the proper exposure according to Program line when taking pictures.

- 1 Set the mode dial to **■**.

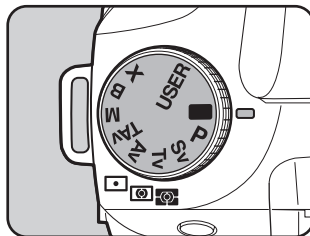

- 2 Confirm the shutter speed and aperture in the viewfinder or on the LCD panel.



Shutter speed, aperture, AE lock, EV compensation, Auto bracket, Multi-exposure, and Flash exposure compensation cannot be set in **■** (Green) mode.



Set the aperture to the **A** position while holding down the auto-lock button when using a lens with an aperture ring.

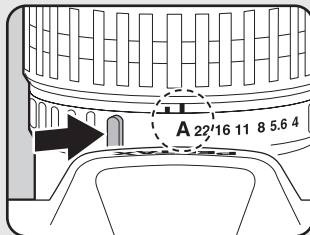

Using the P (Hyper-program) Mode

Automatically sets shutter speed and aperture to the proper exposure according to Program line when taking pictures.

Use the front e-dial and rear e-dial to change the shutter speed and aperture while maintaining the proper exposure (Hyper-program).

1 Set the mode dial to P.

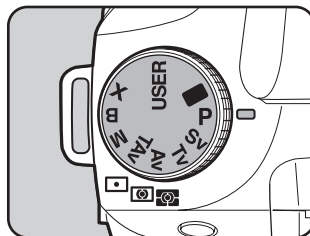

2 Confirm the shutter speed and aperture in the viewfinder or on the LCD panel.

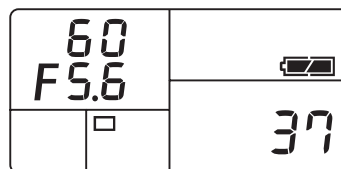

- Set the aperture to the **A** position while holding down the auto-lock button when using a lens with an aperture ring.
- You can change the Program line to use. Set in [1. Program Line] in the [C Custom Setting] menu. (p.82)
- You can automatically correct the sensitivity if appropriate exposure cannot be set with the set criteria. Set [Sensitivity] to [AUTO] in the Fn menu. (p.78)

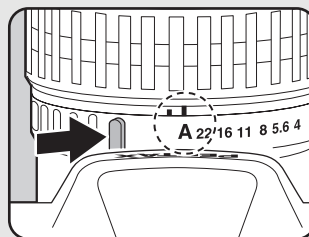

Hyper-program

● To change the shutter speed

You can switch to Shutter Priority automatic exposure by turning the front e-dial in **P** (Hyper-program) mode.

- You can only set the shutter speed to a value that will give a correct exposure with the aperture range of the lens being used.
- If the brightness changes and the aperture value is outside the relative range, the aperture value will blink in the viewfinder and on the LCD panel.
- Press the Green button to return to Hyper-program automatic exposure.

● To change the aperture

You can switch to Aperture Priority automatic exposure by turning the rear e-dial in **P** (Hyper-program) mode.

- You can only set the aperture to a value that will give a correct exposure within the range of available shutter speeds.
- If the brightness changes and the shutter speed is outside the relative range, the shutter speed will blink in the viewfinder and on the LCD panel.
- Press the Green button to return to Hyper-program automatic exposure.

4

Shooting Functions

Using the Sv (Sensitivity Priority) Mode

You can set the sensitivity to suit the brightness of the subject. The shutter speed and aperture are automatically set according to the selected sensitivity to obtain the appropriate exposure.

1 Set the mode dial to Sv.

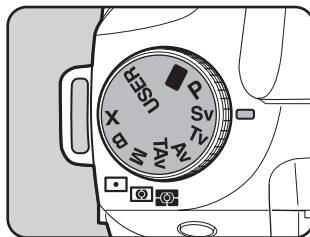

2 Turn the rear e-dial and adjust the sensitivity.

The shutter speed, aperture value and sensitivity are displayed in the viewfinder and on the LCD panel.

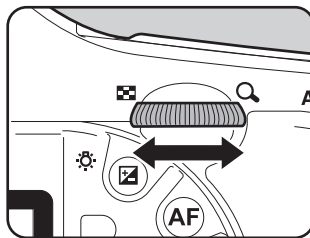

- You can set the sensitivity to values equivalent to ISO 100 to 3200. [AUTO] is not available.
- Turn the front e-dial while pressing the button to change the EV compensation value. (p.100)
- Set the sensitivity in increments of 1/2 EV or 1/3 EV. Set in [2. EV Steps] in the [C Custom Setting] menu. (p.101)
- You cannot set the sensitivity in [Sensitivity] in the Fn menu.
- Set the aperture to the **A** position while holding down the auto-lock button when using a lens with an aperture ring.

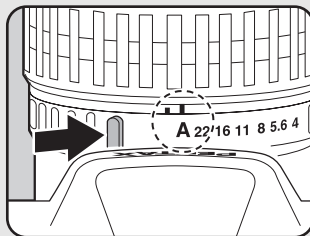

Using the Tv (Shutter Priority) Mode

Lets you set the desired shutter speed for expressing moving subjects. When taking pictures of a fast moving subject, you can increase the shutter speed to make the subject look still or decrease the shutter speed to have the subject show movement.

Aperture value is automatically set to give the appropriate exposure depending on the shutter speed.

☞ Effect of Aperture and Shutter Speed (p.76)

1 Set the mode dial to Tv.

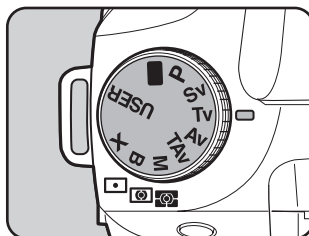

2 Turn the front e-dial and adjust the shutter speed.

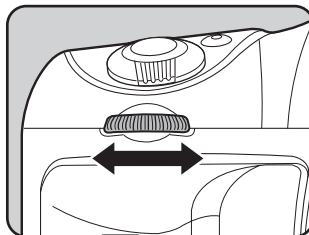

The shutter speed and aperture value are displayed in the viewfinder and on the LCD panel.





- Turn the front e-dial while pressing the button to change the EV compensation value. (p.100)
- Set the shutter speed in increments of 1/2 EV or 1/3 EV. Set in [2. EV Steps] in the [C Custom Setting] menu. (p.101)
- You can automatically correct the sensitivity if appropriate exposure cannot be set with the set criteria. Set [Sensitivity] to [AUTO] in the Fn menu. (p.78)
- Set the aperture to the **A** position while holding down the auto-lock button when using a lens with an aperture ring.

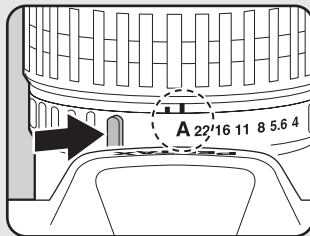

4

Exposure Warning

If the subject is too bright or too dark, the aperture value will blink in the viewfinder and on the LCD panel. If the subject is too bright, choose a faster shutter speed. If it is too dark, choose a slower shutter speed. When the aperture value indication stops blinking, you can take the picture with proper exposure.



Use an ND (Neutral Density) filter if the subject is too bright.
Use a flash if it is too dark.

Using the Av (Aperture Priority) Mode

Set aperture for controlling the depth of field. The depth of field is deeper and the front and back of the focused object is clear when aperture is set to a large value. The depth of field is shallower and the front and back of the focused object is blurred when aperture is set to a small value.

Shutter speed is automatically set to appropriate exposure depending on the aperture value.

☞ Effect of Aperture and Shutter Speed (p.76)

1 Set the mode dial to Av.

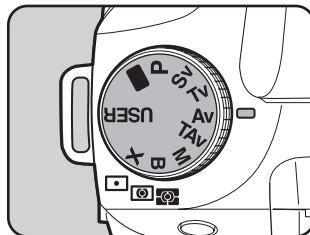

2 Turn the rear e-dial and adjust the aperture value.

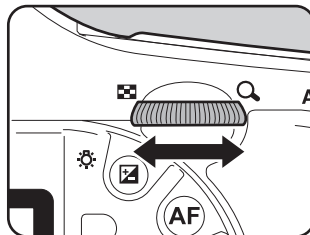

The shutter speed and aperture value are displayed in the viewfinder and on the LCD panel.





- Turn the front e-dial while pressing the button to change the EV compensation value. (p.100)
- Set the aperture value in increments of 1/2 EV or 1/3 EV. Set in [2. EV Steps] in the [C Custom Setting] menu. (p.101)
- You can automatically correct the sensitivity if appropriate exposure cannot be set with the set criteria. Set [Sensitivity] to [AUTO] in the Fn menu. (p.78)
- Set the aperture to the **A** position while holding down the auto-lock button when using a lens with an aperture ring.

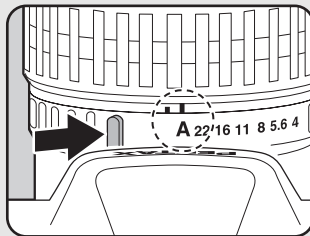

Exposure Warning

If the subject is too bright or too dark, the shutter speed will blink in the viewfinder and on the LCD panel. If the subject is too bright, set the aperture



smaller (larger number), and when too dark, open the aperture further (smaller number). Once blinking stops, you can take the picture. Use an ND (Neutral Density) filter if the subject is too bright. Use a flash if it is too dark.

Using the TAv (Shutter & Aperture Priority) Mode

You can set both the desired shutter speed and aperture to take the picture.

Automatically sets the sensitivity so that the manually set shutter speed and aperture will give the proper exposure according to the brightness of the subject.

1 Set the mode dial to TAv.

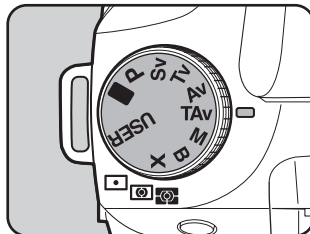

2 Turn the front e-dial and adjust the shutter speed.

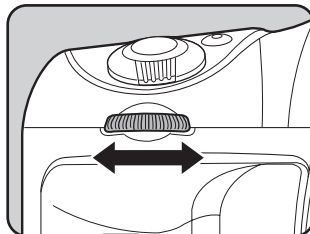

3 Turn the rear e-dial and adjust the aperture value.

The shutter speed, aperture value and sensitivity are displayed in the viewfinder and on the LCD panel.

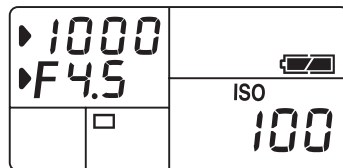
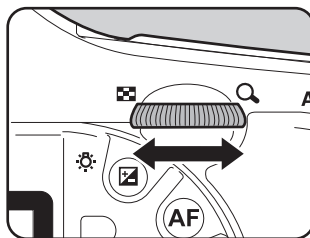



- Turn the front e-dial while pressing the button to change the EV compensation value. (p.100)
- Set the shutter speed and aperture values in increments of 1/2 EV or 1/3 EV. Set in [2. EV Steps] in the [C Custom Setting] menu. (p.101)
- Settings other than [AUTO] are not available in [Sensitivity] in the Fn menu.
- Set the aperture to the **A** position while holding down the auto-lock button when using a lens with an aperture ring.

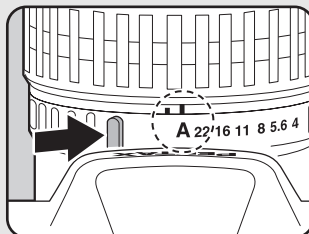

4

Shooting Functions

Exposure Warning

If the subject is too bright or too dark, the sensitivity display will blink in the viewfinder and on the LCD panel.



Change the shutter speed and aperture. When the indication stops blinking, you can take the picture with proper exposure.

Use an ND (Neutral Density) filter if the subject is too bright.

Use a flash if it is too dark.

About the Green Button

The aperture and shutter speed are automatically adjusted to the appropriate exposure at that moment if the Green button is pressed in **TAv** (Shutter & Aperture Priority) mode. You can choose from the following three adjustment methods in [26. Green button in **TAv** & **M**] in the [C Custom Setting] menu.

1	Program Line	The aperture and shutter speed are adjusted automatically.
2	Tv Shift	The aperture is locked and the shutter speed is adjusted automatically.
3	Av Shift	The shutter speed is locked and the aperture is adjusted automatically.

Shutter speed is adjusted to appropriate exposure according to lens aperture when lens aperture is not set to the **A** position.

Notes on [36. Using Aperture Ring] (p.251)

Using M (Hyper-manual) Mode

This mode is convenient for taking pictures using the same shutter speed and aperture setting combination or taking intentionally underexposed (darker) or over-exposed (brighter) photographs.

☞ Effect of Aperture and Shutter Speed (p.76)

1 Set the mode dial to M.

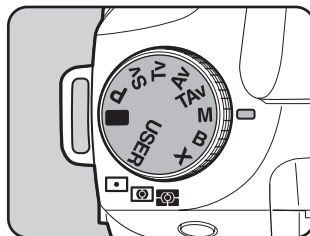

2 Press the Green button.

Automatically switches shutter speed and aperture to the proper exposure.

Turn the front or rear e-dial to change the exposure to your liking and take a picture.

Adjust the shutter speed with the front e-dial and aperture with the rear e-dial.

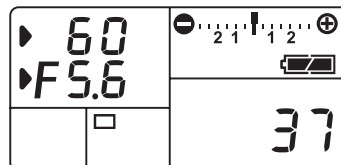
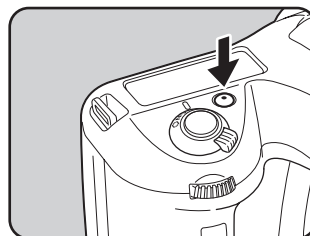



- When the sensitivity is set to [AUTO] and exposure mode is set to **M** (Hyper-manual) mode, the sensitivity is the lowest sensitivity set in “Setting the Range of Automatic Correction in AUTO” (p.78).
- The viewfinder indicator blinks when the difference from appropriate exposure is over ± 3.0 .
- Set the shutter speed and aperture values in increments of 1/2 EV or 1/3 EV. Set in [2. EV Steps] in the [**C** Custom Setting] menu. (p.101)
- Set the aperture to the **A** position while holding down the auto-lock button when using a lens with an aperture ring.

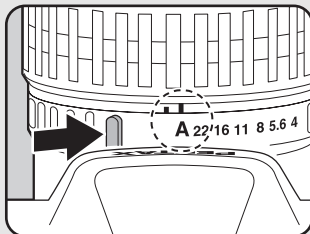

EV Bar

The EV bar appears in the LCD panel and viewfinder in **M** (Hyper-manual) mode. The appropriate exposure is set when **|** is in the middle of the EV bar. If it is towards **-**, it is underexposed. If it is towards **+**, it is overexposed. If the value exceeds the range of the EV bar, the “+” or “-” blinks.



EV bar

Exposure Warning

If the subject is too bright or too dark, “+” or “-” in the EV bar will blink in the viewfinder and on the LCD panel.



Combining with AE-L

Press the **AE-L** button (p.102) to record the exposure value in Hyper-manual. If the shutter speed or aperture is then changed, the combination of shutter speed and aperture changes while exposure is retained.

Example: If the shutter speed is 1/125 sec and aperture is F5.6 and is recorded with the **AE-L** button, and the shutter speed is changed to 1/30 sec with the front e-dial, the aperture automatically changes to F11.

About the Green Button

The aperture and shutter speed are automatically adjusted to the appropriate exposure at that moment if the Green button is pressed in **M** (Hyper-manual) mode. You can choose from the following three adjustment methods in [26. Green button in **TAv & M**] in the [**C** Custom Setting] menu.

1	Program Line	The aperture and shutter speed are adjusted automatically.
2	Tv Shift	The aperture is locked and the shutter speed is adjusted automatically.
3	Av Shift	The shutter speed is locked and the aperture is adjusted automatically.

Shutter speed is adjusted to appropriate exposure according to lens aperture when lens aperture is not set to the **A** position.

☞ Notes on [36. Using Aperture Ring] (p.251)

Using the **B** (Bulb) Mode

This mode is useful for the long exposures required for shooting night scenes and fireworks.

The shutter remains open as long as the shutter release button is kept pressed.

1 Set the mode dial to **B**.

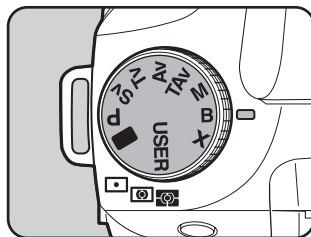

4



- EV compensation, Continuous shooting and Exposure Bracket are not available in **B** (Bulb) mode.
- The longer the exposure time, the greater noise in the captured image.



- Turn the rear e-dial to adjust the aperture value.
- Set the aperture value in increments of 1/2 EV or 1/3 EV. Set in [2. EV Steps] in the [**C** Custom Setting] menu. (p.101)
- The Shake Reduction function is automatically turned off when exposure mode is set to **B** (Bulb) mode.
- Use a sturdy tripod and the cable switch CS-205 (optional) to prevent camera shake when using **B** (Bulb) mode. Connect the cable switch to the cable switch terminal (p.17).
- Bulb shooting is available when using the remote control shooting mode (p.125). The shutter remains open as long as the shutter release button of the optional remote control is held down.
- When the sensitivity is set to [AUTO] and exposure mode is set to **B** (Bulb) mode, the sensitivity is the lowest sensitivity set in "Setting the Range of Automatic Correction in AUTO" (p.78).
- When the exposure mode is set to **B** (Bulb), the upper sensitivity limit is ISO 1600.
- There is no limit on exposure time for Bulb shooting. However, we recommend using the AC adapter D-AC50 (optional) when shooting with a long exposure setting as the battery is used while the shutter remains open.

Using the X (Flash X-Sync Speed) Mode



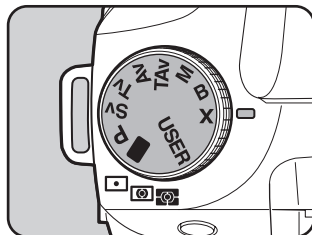

The shutter speed is locked at 1/180 seconds. Use this when using an External flash that does not automatically change the shutter speed.



1 Set the mode dial to X.



- Turn the rear e-dial to adjust the aperture value.
- Press the Green button to retain the shutter speed at 1/180 sec and automatically adjust the aperture.
- When the sensitivity is set to [AUTO] and exposure mode is set to **X** (Flash X-sync speed) mode, the sensitivity is the lowest sensitivity set in “Setting the Range of Automatic Correction in AUTO” (p.78).

Selecting the Metering Method

Choose the part of the screen to use for measuring brightness and determining exposure.  (Multi-segment metering),  (Center-weighted metering) or  (Spot metering) mode can be selected. The factory default setting is  (Multi-segment metering).

	Multi-segment	Segments the viewfinder in 16 parts, meters each portion and determines the appropriate exposure.
	Center-weighted	Measures the entire viewfinder with an emphasis on the center and determines the exposure.
	Spot Metering	Measures only the center of the viewfinder and determines exposure.

4

Shooting Functions

Set with the metering mode lever. (p.19)

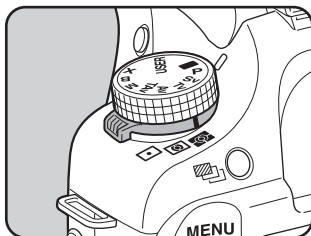

Using the Multi-Segment Metering

The scene in the viewfinder is metered in 16 different zones as shown in the illustration when using the multi-segment metering. Even in backlit locations, this mode automatically determines what level of brightness is in which portion and automatically adjusts exposure.

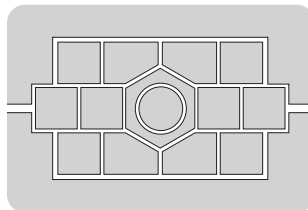

The center-weighted metering mode is automatically set even if you select the multi-segment metering mode when using a lens other than a DA, D FA, FA J, FA, F or A lens, or when lens aperture ring is set at other than **A**. (Can only be used if permission is set in [36. Using aperture ring] (p.75) in the [C Custom Setting] menu.)

Linking AF Point and AE During Multi-Segment Metering

In [7. Link AF Point and AE] (p.73) of the [C Custom Setting] menu, you can link the exposure and AF point in the focusing area during multi-segment metering. The default setting is [Off].

1	Off	Exposure is set separately from AF point.
2	On	Exposure is set in accordance with AF point.

Using the Center-Weighted Metering

Metering is weighted at the center of the screen. Use this metering when you want to compensate the exposure by experience, instead of leaving it to the camera. The illustration shows that sensitivity increases as the pattern height increases (center). This mode does not automatically compensate for backlit scenes.

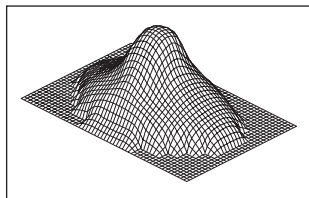

Using the Spot Metering

With spot metering, brightness is measured only within a limited area at the center of the screen as shown in the illustration. You can use this in combination with the AE lock (p.102) when the subject is extremely small and proper exposure is difficult to obtain.

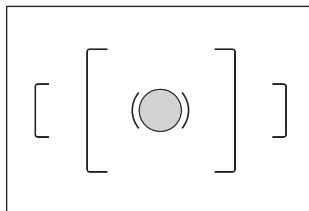

Setting the Meter Operating Time

Sets the exposure metering time in [5. Meter Operating Time] (p.73) in the [C Custom Setting] menu. The default setting is [10 sec].

1	10 sec	Sets exposure metering timer to 10 seconds.
2	3 sec	Sets exposure metering timer to 3 seconds.
3	30 sec	Sets exposure metering timer to 30 seconds.

Adjusting the Exposure

This allows you to deliberately overexpose (brighten) or under-expose (darken) your picture.

Select 1/2 EV or 1/3 EV in [2. EV Steps] in the [C Custom Setting] menu. (p.101)

You can adjust the EV Compensation from -3 to +3 (EV) in increments of 1/2 EV or -2 to +2 (EV) in increments of 1/3 EV.

- 1 **Set the compensation with the front e-dial while the  button is pressed.**

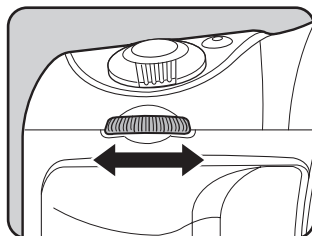
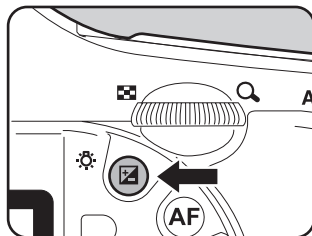

 is displayed in the viewfinder and on the LCD panel during compensation.

Press the  button to confirm the compensation value.

 is displayed when the flash exposure compensation (p.136) is set.



Compensation value

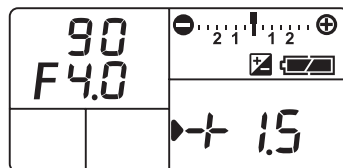



EV compensation is not available when the exposure mode is set to  (Green) or **B** (Bulb) mode.



- The EV compensation cannot be canceled by turning the camera off or by setting any other exposure mode.
- The EV compensation value is reset to 0 when the Green button is pressed while holding down the  button.

EV Compensation for **M** (Hyper-manual) and **X** (Flash X-sync speed)

For example, if the EV compensation value is set to +1.5 for **M** and **X**, an underexposure of 1.5EV is displayed on the EV bar. If you set the exposure value so that the  is displayed at the center of the EV bar, the image will be captured with the compensated value.



Changing the Exposure Steps

Set Exposure Steps in [2. EV Steps] in the [**C** Custom Setting] menu to increments of 1/2 EV or 1/3 EV.

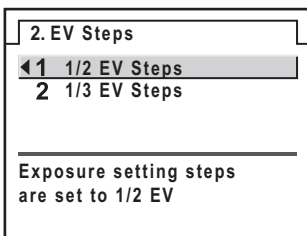

Recording the Exposure Before Shooting (AE Lock)

AE Lock is a function that memorizes the exposure prior to taking the picture. Use this when the subject is too small or backlit and a proper exposure setting cannot be obtained.

1 Press the **AE-L** button.

The camera memorizes the exposure (brightness) at that instant. Press it again to unlock.

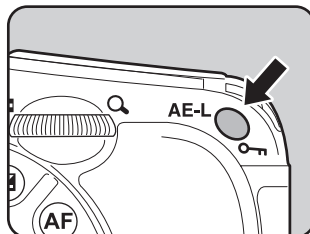

4



- * is displayed in the viewfinder while the AE lock is engaged. (p.27)
- The exposure remains locked as long as the **AE-L** button is kept pressed or the shutter release button is kept pressed halfway. The exposure remains in memory for a period between 0.5× to 2× the metering timer after releasing the **AE-L** button.
- You will hear a beep when the **AE-L** button is pressed. The beep can be turned off. (p.219)
- AE lock is not available when the exposure mode is **■** (Green), **B** (Bulb) or **X** (Flash X-sync speed) mode.
- The combination of shutter speed and aperture value changes depending on the zooming position even while the AE lock is engaged when using a zoom lens for which maximum aperture varies depending on the focal length. However, the exposure value does not change and the picture is taken at the brightness level set by the AE lock.
- Exposure can be locked when focus is locked. Set in [6. AE-L with AF locked] in the [**C** Custom Setting] menu. (p.110)

Shooting in Multi-exposure Mode

You can take multiple frames while creating a single picture.

- 1 **Select [Multi-exposure] in the [Rec. Mode] menu and press the four-way controller (▶).**

The Multi-exposure screen appears.

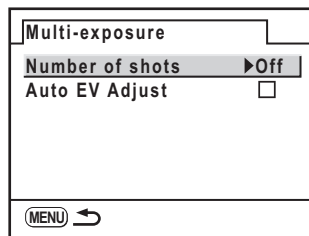

- 2 **Use the four-way controller (▶) to select the number of shots.**

Use the four-way controller (▲▼) to select from 2 to 9 shots.

- 3 **Press the OK button.**

- 4 **Use the four-way controller (▼) to set Auto EV Adjust.**

- 5 **Use the four-way controller (▶) to set Auto EV Adjust to (On) or (Off).**

When (On) is set, the exposure is adjusted automatically according to the number of shots.

- 6 **Press the OK button twice.**

The camera returns to the Capture mode.

- 7 **Take the picture.**

The created picture is displayed in Instant Review each time the shutter release button is pressed. Press the  button during Instant Review to discard pictures created to that point and create again from the first picture.

The picture is saved when the set number of shots has been taken.



- If the **RAW** button or **MENU** button is pressed, or the Exposure Bracket is set during Multi-exposure shooting, the pictures that have already been taken are saved and Multi-exposure is exited.
- Multi-exposure and Auto Bracket or Extended Bracket cannot be used together. The mode set last is used.

Focusing

You can focus with the following methods.

AF	Autofocus	The camera is focused when the shutter release button is pressed halfway.
MF	Manual focus	Manually adjust the focus.

Using the Autofocus

You can also choose the autofocus mode from **A.F.S.** (Single mode) where the shutter release button is pressed halfway to focus on the subject and the focus is locked at that position, and **A.F.C.** (Continuous mode) where the subject is kept in focus by continuous adjustment while the shutter release button is pressed halfway. The factory default setting is **A.F.S.**

4

Shooting Functions

1 Set the focus mode lever to A.F.S. or A.F.C.

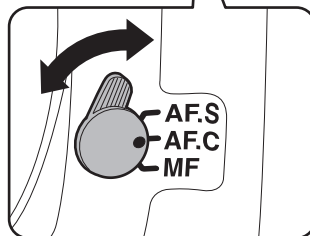
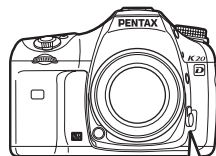

A.F.S.	Single mode	When the shutter release button is pressed halfway to focus on the subject, the focus is locked at that position.
A.F.C.	Continuous mode	The subject is kept in focus by continuous adjustment while the shutter release button is pressed halfway. Even if the subject is not in focus, the shutter can be released when the shutter release button is pressed fully.

2 Look through the viewfinder and press the shutter release button halfway.



The focus indicator  appears in the viewfinder when focused. (When blinking, the subject is not in focus.)

 Subjects that are Difficult to Focus on (p.58)



Focus Indicator



- The camera can be focused by pressing the **AF** button as well as by pressing the shutter release button halfway.
- In **A.F.S** (Single mode), the focus is locked (focus lock) while  is lit. To focus on another subject, take your finger off the shutter release button first.
- In **A.F.C** (Continuous mode) (p.104), focus is adjusted continuously, tracking the moving object as long as the shutter release button is kept pressed halfway.
- The shutter cannot be released until the subject is in focus in **A.F.S** (Single mode) (p.104). If the subject is too close to the camera, move back and take the picture. Adjust the focus manually if it is difficult to focus on the subject (p.58). (p.110)
- In **A.F.S** (Single mode), press the shutter release button halfway. The built-in flash will discharge automatically several times, enabling the autofocus to focus on the subject more easily if the subject is in a dark area and the built-in flash is available.
- When the shutter release button is pressed halfway to focus and the subject is determined to be a moving object, the **A.F.C** automatically tracks the subject. The lens will automatically operate and continuously focus on the subject.

AF Adjustment



You can adjust the AF focusing position with [35. AF Adjustment] in the [**C** Custom Setting] menu.



- **Be sure to use AF Adjustment only when necessary. Care should be taken as adjusting the autofocus may make it difficult to capture images with the appropriate focus.**
- Any camera shake during test shooting for focus adjustment may make it difficult to obtain the accurate focusing position. Therefore, always use a tripod when taking test shots.

- 1 Select [35. AF Adjustment] in the [**C** Custom Setting] menu and press the four-way controller (▶).
- 2 Press the four-way controller (▲▼) to select [On] and press the four-way controller (▶).
The AF Adjustment screen appears.
- 3 Use the four-way controller (▲▼) to select [Apply All] or [Apply One].

Apply All	Applies the same adjustment value to all lenses.
Apply One	The lens ID is displayed when obtained. Saves and applies an adjustment value for each lens type. (Up to 20 lens types)

- 4 Press the four-way controller (▶) and adjust the value with the rear e-dial or the four-way controller (◀▶).
Press the four-way controller (▶) (rear e-dial ) to adjust the focus to a closer position and press the four-way controller (◀) (rear e-dial ) to adjust the focus to a farther position.

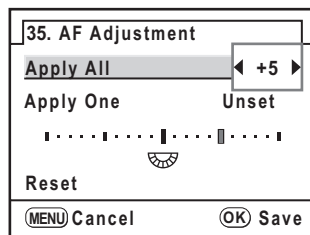

- 5 Press the **OK** button.
- 6 Press the **OK** button.
The camera returns to the Capture mode.
- 7 Take a test picture.

You can check the focusing position by enlarging the image during Live View (p.114) or Digital Preview (p.115).





- Press the Green button in Step 4 to set the adjustment value to ± 0 .
- If an adjustment value has been saved using Apply One and you press the **OK** button with [Apply All] selected in Step 6, the Apply All value is used instead of the Apply One value.
- To reset a saved adjustment value, select [Reset] on the AF Adjustment screen in Step 3. (p.241)

Selecting the Focusing Area (AF Point)

Choose the part of the viewfinder to set focus to. The factory default setting is  **AUTO** (Auto).

The selected AF point lights red in the viewfinder. (Superimpose AF Area)

 AUTO	Auto	The camera selects the optimum AF point even if the subject is not centered.
SEL	Select	Sets the focusing area to one of the eleven points in the AF area.
	Center	Sets the focusing area to the center of the viewfinder.

Set with the AF point switching dial. (p.19)



- AF point is not displayed in the viewfinder when [Off] is selected for [15. Superimpose AF Area] in the [**C** Custom Setting] menu. (p.74)
- When [Center AF Point] is selected in [13. **AF** Button Function] in the [**C** Custom Setting] menu, the camera can be set to return the AF point to the center when **SEL** (Select) is set and the **AF** button is pressed. (p.73)
- The AF point is fixed to the center position regardless of this setting with lenses other than DA, D FA, FA J, FA or F lenses.

Setting the Focus Position in the Viewfinder

- 1** Select **SEL** (Select) with the AF point switching dial.

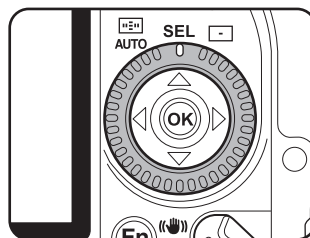

- 2** Look through the viewfinder and check the position of the subject.

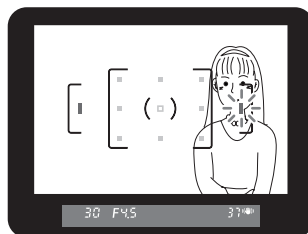

- 3** Use the four-way controller (▲▼◀▶) to select the desired AF point.

The AF point lights red in the viewfinder (Superimpose AF Area) and you can check where you set the AF point.

Fixing the Focus (Focus Lock)

If the subject is outside the range of the focusing area, the camera cannot automatically focus on the subject. In this situation, set the focus mode lever to **AF.S** (Single mode). You can aim the focusing area toward the subject, use focus lock and recompose the picture.

- 1** Frame the desired composition for your picture in the viewfinder.

Use focus lock function when the subject you wish to focus on is not inside the focusing area.

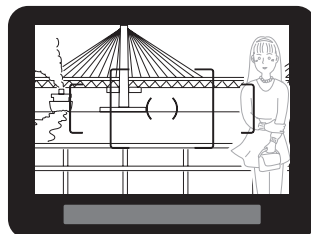

(Example) The person is out of focus and the background is focused instead.

2 Center the subject to focus in the viewfinder and press the shutter release button halfway.

The focus indicator  appears and you will hear a beep when the subject comes into focus. (When blinking, the subject is not in focus.)

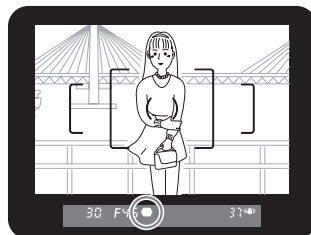

3 Lock the focus.

Keep the shutter release button pressed halfway. The focus will remain locked.

4 Re-compose the picture while keeping the shutter release button pressed halfway.

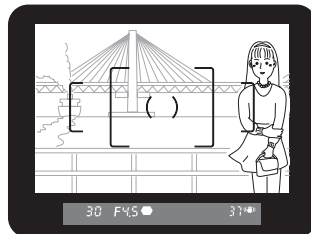

- The focus is locked while the focus indicator  is lit.
- Turning the zoom ring in focus lock mode may cause the subject to be out of focus.
- The beep can be turned off. (p.219)

Locking Exposure when Focus is Locked

Set [6. AE-L with AF locked] in the [C Custom Setting] menu (p.73) to lock the exposure value while focus is locked. Exposure is not locked by default during focus lock.

1	Off	Exposure is not locked when focus is locked.
2	On	Exposure is locked when focus is locked.

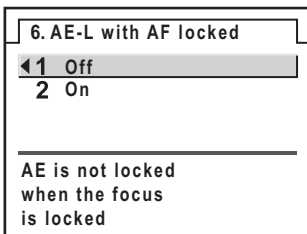



4

Adjusting the Focus Manually (Manual Focus)

When you adjust the focus manually, you can either check with the focus indicator in the viewfinder or use the viewfinder matte field to adjust focus.

Using the Focus Indicator

The focus indicator  appears when the subject is in focus even during manual focus.

You can manually adjust the focus using the focus indicator .

- 1 Set the focus mode lever to **MF**.

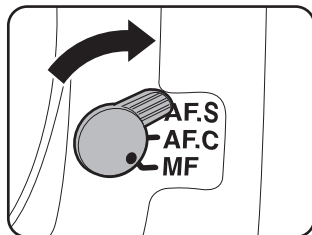

- 2** Look through the viewfinder, press the shutter release button halfway and turn the focusing ring.

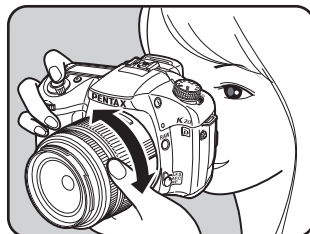

The focus indicator  appears and you will hear a beep when the subject comes into focus.



Focus Indicator



- Focus manually using the matte field in the viewfinder when the subject is difficult to focus (p.58) and the focus indicator will not stay lit.
- The beep can be turned off. (p.219)

Using the Viewfinder Matte Field

You can manually adjust the focus using the viewfinder matte field.

- 1** Set the focus mode lever to **MF**.

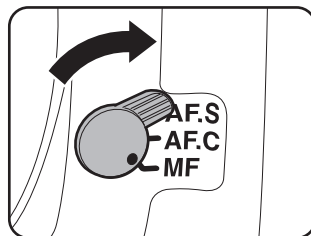

- 2** Look through the viewfinder and turn the focusing ring until the subject looks sharp on the focusing screen.

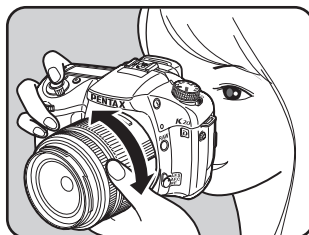

Using the AF Button

The **AF** button operates the autofocus mechanism in the same manner as when the shutter release button is pressed halfway. (Capturing is performed with the shutter release button.)

When the subject is focused with the **AF** button in **A.F.S** (Single mode), focus lock is activated while the button is pressed.

The subject will continue to be focused (Autofocus activates) while the **AF** button is pressed in **A.F.C** (Continuous mode).

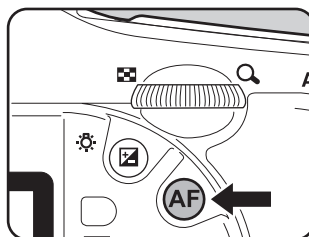

4

Shooting Functions

Shooting in Catch-in Focus Mode

When [34. Catch-in focus] is set to On in the [C Custom Setting] menu, if the focus mode is set to **A.F.S** and one of the following types of lenses is attached, catch-in focus shooting is possible and the shutter is released automatically when the subject comes into focus.

- Manual focus lens
- DA or FA lens that has a **AF** and **MF** setting on the lens (the setting on the lens must also be set to **MF** before shooting)

● How to Take Pictures

- 1 Attach lens to the camera.
- 2 Set the focus mode lever to **A.F.S**.
- 3 Set focus on a position the subject will pass.
- 4 Use the cable switch CS-205 and press the shutter release button fully.

The shutter is released automatically when the subject comes into focus in the set position.

Checking the Composition, Exposure and Focus Before Shooting

You can use the preview function to check the depth of field, composition, exposure and focus before taking a picture. There are 3 preview methods.

Live View	Displays a real-time image on the monitor.
Optical Preview	For checking the depth of field with the viewfinder.
Digital Preview	For checking the composition, exposure and focus in the monitor.

Selecting the Preview Method

Choose whether to use Live View, Optical Preview, or Digital Preview when the main switch is turned to the preview position (⌂).

The default setting is Live View.

Set in [30. Preview Method] in the [C Custom Setting] menu. (p.74)

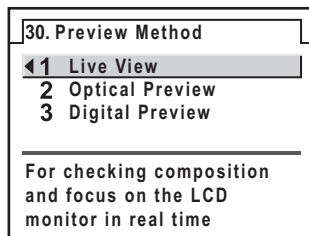

While setting Multi-exposure (p.103), preview is Optical Preview regardless of the [30. Preview Method] setting.

Displaying the Preview

Displaying the Live View

1 Focus on the subject, and then turn the main switch to .

The mirror raises and a real-time image is displayed on the monitor. Turn the main switch to  again to exit Live View.



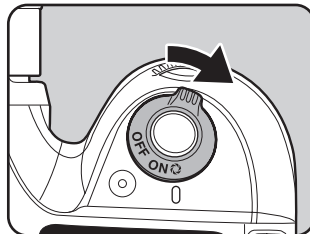

Live View can be displayed for up to 3 minutes.





4

Shooting Functions



- If Live View is used in places where the camera may become hot, such as in direct sunlight,  (temperature warning) may appear on the monitor. Cancel Live View, as the internal temperature of the camera is rising.
- If Live View is used even after  (temperature warning) appears, Live View may end before 3 minutes elapse. Normal shooting is possible even if Live View is ended.
- Even when the main switch is turned to , if the internal temperature of the camera is high,  (temperature warning) will appear on the monitor and Live View may not be possible.
- When the focus mode is set to **A.F.S** and the **AF** button is pressed during Live View, the displayed image will disappear and AF will activate. Once focused, the image will be displayed in Live View again.
- AF using the shutter release button is not available during Live View.
- Aperture, shutter speed, sensitivity, EV compensation, and exposure bracket cannot be changed during Live View.
- The aperture value and shutter speed are not displayed in the LCD panel or shooting information screen during Live View.



- Live View is exited after 3 minutes elapse, or if the **MENU** button, **Fn** button, or  button is pressed.
- The grid and AF frame can be displayed during Live View. Set in [Live View] (p.228) in the [ Playback] menu.
- You can magnify the image during Live View with the rear e-dial. (p.174)
- Shooting while holding the camera by hand and viewing the monitor can create camera shake. Use of a tripod is recommended.
- Live View is not available when data is being saved to an SD Memory Card.

Displaying the Optical Preview

- 1 Position the subject inside the AF frame and press the shutter release button halfway to focus on the subject.**

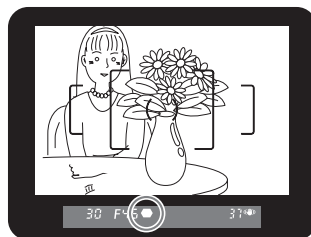

- 2 Turn the main switch to  while looking through the viewfinder.**

You can check the depth of field in the viewfinder while the main switch is on .

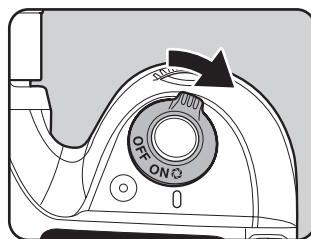



- No shooting information is displayed in the viewfinder, and the shutter cannot be released while the main switch is in the preview position (.
- You can check the depth of field in all exposure modes.

4

Shooting Functions

Displaying the Digital Preview

- 1 Focus on the subject, then compose the picture in the viewfinder and move the main switch to .**

The icon () appears in the monitor during preview and you can check the composition, exposure and focus.

Press the shutter release button halfway to end Digital Preview and start focusing.

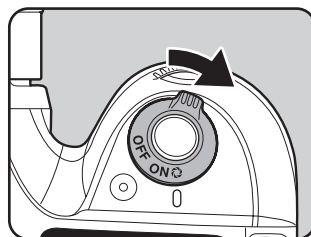









- You can display the Bright/Dark area warning or histogram in Digital Preview. Set in [Digital Preview] (p.229) in the [▶ Playback] menu.
- The maximum display time for Digital Preview is 60 seconds.
- You can magnify the image during Digital Preview with the rear e-dial. (p.174)
- Press the **Fn** button during Digital Preview to save the preview image as a JPEG image. The image save confirmation screen appears. Select [Save as] and press the **OK** button.

Continuous Shooting

Pictures can be taken continuously while the shutter release button is held down.

You can select from  (Continuous shooting (Hi)) and  (Continuous shooting (Lo)) for continuous shooting.

 Continuous shooting (Hi)	When JPEG quality is set to  (Quality Level ★★★), pictures are taken continuously at approximately 3 frames per second. Up to 38 frames can be shot in one sequence.
 Continuous shooting (Lo)	When JPEG quality is set to  (Quality Level ★★★), pictures are taken continuously at approximately 2.3 frames per second. Pictures can be taken continuously until the SD Memory Card is full.

1 Press the Fn button.

The Fn menu appears.

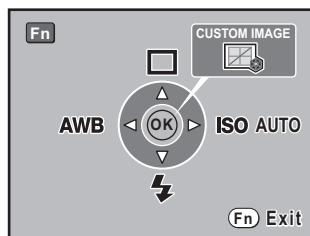

2 Press the four-way controller (▲).

The Drive Mode options screen appears.

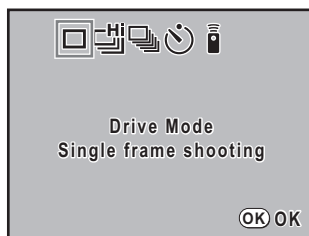

3 Use the four-way controller (◀▶) to select .

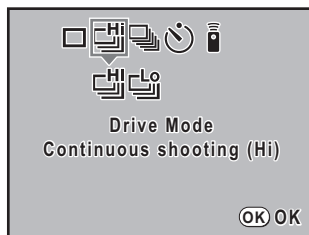

4 Press the four-way controller (▼) and use the four-way controller (◀▶) to select  or .

5 Press the OK button.

The camera is ready to take pictures continuously.



6 Press the shutter release button halfway.

The autofocus system operates. The focus indicator  appears in the viewfinder when focused.

7 Press the shutter release button fully.

Pictures are taken continuously while the shutter release button is fully pressed. Take your finger off the shutter release button to stop.



- If the focus mode is set to **A.F.S** (Single mode), the focus position is locked on the first frame and pictures are taken continuously at the same interval.
- Focusing is continuously active during continuous shooting when the focus mode is set to **A.F.C** (Continuous mode).
- The shutter cannot be released until charging is complete when using the built-in flash. You can set the camera to enable shutter release before the built-in flash is ready in the [**C** Custom Setting] menu. (p.137)
- You can also use the remote control for continuous shooting. (p.125)
- Select a setting other than  in the Drive Mode options screen to cancel continuous shooting. The setting is canceled when the camera is turned off if [Drive Mode] in [Memory] of the [ Rec. Mode] menu (p.236) is set to (Off).

Burst Shooting

You can take pictures continuously at approximately 21 frames per second. In this mode, images are saved with JPEG Rec. Pixels set to **1.6M** (1536×1024) regardless of the save format setting (p.156). The JPEG Quality set in the [Rec. Mode] menu is used.

1 Press the Fn button.

The Fn menu appears.

2 Press the four-way controller (▲) and use the four-way controller (◀▶) to select .

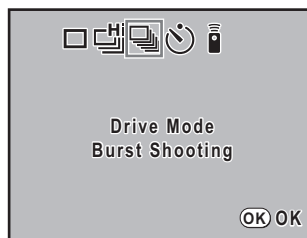

3 Press the OK button.

The camera is ready to take pictures continuously.

4 Press the shutter release button halfway.

The autofocus system operates. The focus indicator  appears in the viewfinder when focused.

5 Press the shutter release button fully.

Pictures are taken continuously while the shutter release button is fully pressed until the camera buffer memory is full (JPEG Quality ★★★: maximum of approximately 115 pictures). The focus is locked during shooting.



- The mirror raises during shooting and Instant Review is displayed continuously on the monitor.
- The flash is turned off and the **RAW** button operation is unavailable in this mode.
- Multi-exposure and Auto Bracket are disabled in this mode.
- Select a setting other than  in the Drive Mode options screen to cancel burst shooting. The setting is canceled when the camera is turned off if [Drive Mode] in [Memory] of [Rec. Mode] menu (p.236) is set to (Off).

Interval Shooting

During interval shooting, pictures are taken at a set interval from a set time.

- 1** Select [Interval Shooting] in the [📷 Rec. Mode] menu.
- 2** Press the four-way controller (▶).
- 3** Use the four-way controller (◀▶) to select (On).

Interval Shooting <input checked="" type="checkbox"/>	
Interval	00:00'01"
Number of Shots	1img
Start Trigger	Now
Start Time	
(MENU) Cancel	(OK) OK

- 4** Use the four-way controller (▼) to select [Interval].
When taking two or more pictures, set the wait time until the next picture is taken. Use the four-way controller (◀▶) to select the number of hours, minutes, and seconds, and press the four-way controller (▲▼) to set the time. You can set up to 24 hours, 0 minutes, and 0 seconds.

- 5** Use the four-way controller (▼) to select [Number of Shots].
Set the number of shots to be taken. Press the four-way controller (▶) and use the four-way controller (▲▼) to select the number of shots to be taken. You can select between 1 and 99 shots.

- 6** Use the four-way controller (▼) to select [Start Trigger].
Set the time when the first picture is taken. Press the four-way controller (▶) and use the four-way controller (◀▶) to select [Now] or [Set Time].

Now	Shooting starts immediately.
Set Time	Shooting starts at the set time. Use the four-way controller (▼) to select [Start Time], use the four-way controller (◀▶) to select the time, and press the four-way controller (▲▼) to set the start time.

7 Press the OK button.

The camera is ready to take a series of interval pictures.

8 Press the shutter release button halfway.

The focus indicator  appears when the subject is in focus.



9 Press the shutter release button fully.

When [Start Trigger] is set to [Now], the first picture is taken. When set to [Set Time], shooting starts at the set time.

For shooting multiple pictures, pictures are taken at the interval set in Step 4.

After the set number of pictures is taken, the camera returns to normal Capture mode.





- The camera cannot be operated during interval shooting. To cancel interval shooting, press any button on the back of the camera or press the shutter release button and the **MENU** button to display the exit confirmation screen, and then use the four-way controller ( ) to select [Exit] and press the **OK** button. You can also exit Interval shooting by turning the main switch off or turning the mode dial.
- This function cannot be used together with Auto Bracket or Multi-exposure.
- This function cannot be used during **B** (Bulb) mode. Bulb-timer shooting is available with the use of the provided PENTAX REMOTE Assistant 3 when the camera is connected to a PC.
- The drive mode is set to [Single frame shooting] regardless of the drive mode setting.
- If the subject is not in focus in **A.F.S** (Single mode) or if the [Interval] setting is too short and image processing cannot be completed before taking a picture, no picture may be taken.
- Although each shot taken is displayed on the monitor with Instant Review, they cannot be enlarged or deleted.



- The [Interval] setting is disabled when [Number of Shots] is set to [1].
- Interval shooting is canceled when the SD Memory Card has no more available memory.
- If Auto Power Off (p.233) turns the camera off during interval shooting, the camera automatically turns on again when the shooting time approaches.
- It is recommended to use the AC adapter when using interval shooting over a long period of time.

Self-Timer Shooting

This camera has two types of self-timers:  and .

	Shutter will be released after about 12 seconds. Use this mode to include the photographer in the picture.
	A mirror pops up immediately after shutter release button is pressed. Shutter is released after about 2 seconds. Use this mode to avoid camera shake when the shutter release button is pressed.

1 Mount the camera onto a tripod.

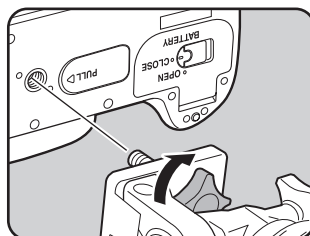

2 Press the Fn button.

The Fn menu appears.

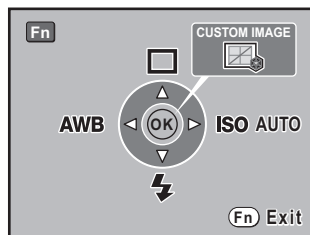

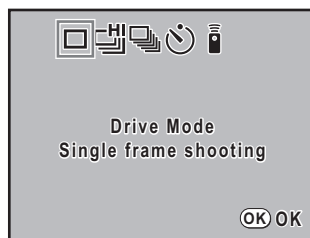

3 Press the four-way controller (▲).

The Drive Mode options screen appears.



4 Use the four-way controller (◀▶) to select .

- 5** Press the four-way controller (▼) and use the four-way controller (◀▶) to select  or .



- 6** Press the OK button.

The camera is ready to take a picture.

- 7** Confirm in the viewfinder that the subject you wish to shoot is properly framed and press the shutter release button halfway.

The focus indicator  appears when the subject is in focus.



- 8** Press the shutter release button fully.

For , the front and back self-timer lamps start blinking slowly and blink rapidly 2 seconds before the shutter is released. The beep is heard and the rate increases. The shutter will be released about 12 seconds after the shutter release button is pressed fully.

For , the shutter will be released about 2 seconds after the shutter release button is pressed fully.

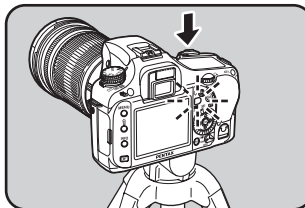
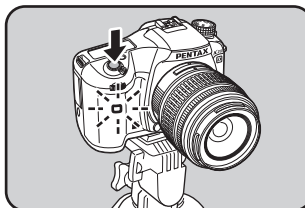



- The beep can be turned off (p.219).
- Exposure may be affected if light enters the viewfinder. Attach the provided ME viewfinder cap or use the AE lock function (p.102). (To ignore the light entering the viewfinder, set the exposure mode to **M** (Hyper-manual) (p.93).)

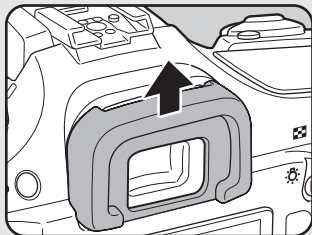

Removing the Eyecup Fp

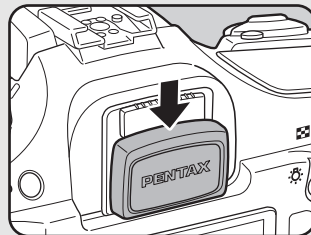



Attaching the ME Viewfinder cap



4

Shooting Functions

- Select a setting other than ☺ or ☹ in the Drive Mode options screen to cancel self-timer shooting. The setting is canceled when the camera is turned off if [Drive Mode] in [Memory] of [📷 Rec. Mode] menu (p.236) is set to ☐ (Off).
- The Shake Reduction function is automatically turned off when ☺ or ☹ is set.

Remote Control Shooting (Remote Control F: Sold Separately)

The shutter can be released from a distance by using the optional remote control unit. You can select from  (remote control),  (3 sec. delayed release), or  (remote continuous shooting) for remote control shooting.

	The shutter will be released immediately after the shutter release button on the remote control unit is pressed.
	When the shutter release button on the remote control unit is pressed, the shutter is released after about 3 seconds.
	Continuous shooting starts when the shutter release button on the remote control unit is pressed. Press the shutter release button on the remote control unit again to exit continuous shooting.

1 Mount the camera onto a tripod.

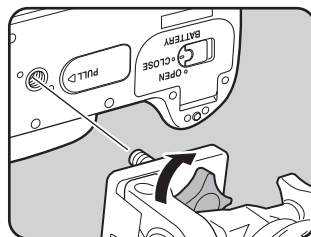

2 Press the Fn button.

The Fn menu appears.

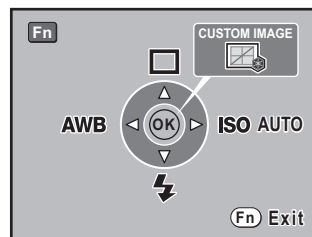

3 Press the four-way controller (▲).

The Drive Mode options screen appears.

4 Use the four-way controller (◀▶) to select .

5 Press the four-way controller (▼) and use the four-way controller (◀▶) to select , , or .

The self-timer lamp will blink to let you know that the camera is in remote control wait status.



6 Press the OK button.

The camera is ready to take a picture.

7 Press the shutter release button halfway.

The autofocus system operates. The focus indicator  appears in the viewfinder when focused.



You cannot focus with the remote control unit in default settings. Focus on the subject first before operating with the remote control. You can set [AF in remote control] to [On] in the [C Custom Setting] menu. (p.74)

8 Point the remote control unit towards the remote control receiver on the front or back of the camera and press the shutter release button on the remote control.

The operating distance of the remote control unit is about 5 m from the front or back of the camera.

For , the shutter will be released immediately after the shutter release button is pressed.

For , the shutter will be released in three seconds after the shutter release button is pressed.

After the picture is taken, the self-timer lamp lights for 2 seconds and then returns to blinking.

For , continuous shooting starts immediately after the shutter release button is pressed. To exit continuous shooting, press the shutter release button on the remote control unit again.

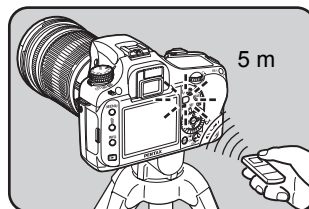
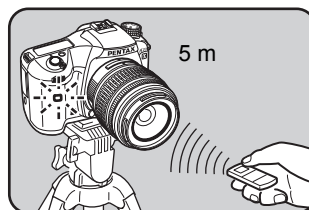



- Exposure may be affected if light enters the viewfinder. Attach the provided ME viewfinder cap or use the AE lock function (p.102). (To ignore the light entering the viewfinder, set the exposure mode to **M** (Hyper-manual) (p.93).)

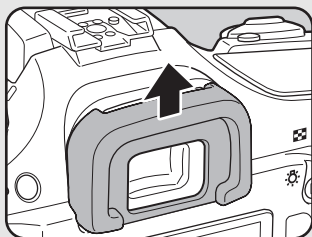

Removing the Eyecup Fp

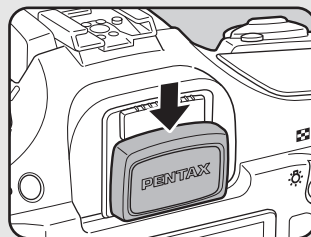

Attaching the ME Viewfinder cap

- Select a setting other than , or in the Drive Mode options screen to stop the remote control operation after it has been activated. The setting is canceled when the camera is turned off if [Drive Mode] in [Memory] of [📷 Rec. Mode] menu (p.236) is set to (Off).
- The remote control may not operate in backlit conditions.
- The remote control does not work while the flash is being charged.
- When using the built-in flash, raise the flash into position first.
- The remote control unit battery can send a remote control signal about 30,000 times. Contact PENTAX Service Center to replace the battery (this will involve a fee).
- The Shake Reduction function is automatically turned off when , or is set.

Using Mirror Up Function to Prevent Camera Shake

Use the Mirror Up function if camera shake is evident even when cable switch (optional) or remote control unit (optional) is used with a tripod. When shooting with the 2 sec. Self-Timer, the mirror pops up and the shutter is released 2 seconds after you press it, thereby avoiding the vibration of the mirror.

Follow the procedure below to take a picture with the Mirror Up function.

- 1 Mount the camera onto a tripod.**
- 2 In the Drive Mode, select  (2 sec. Self-Timer).**

 Self-Timer Shooting (p.122)

- 3 Press the shutter release button halfway.**

The autofocus system operates. The focus indicator  appears in the viewfinder when focused.

- 4 Press the shutter release button fully.**

The mirror pops up and the picture is taken 2 seconds later. AE lock is enabled with the exposure value set immediately before the mirror goes up.



The Shake Reduction function is automatically turned off when shooting with the 2 sec. Self-Timer.

Changing the Shooting Conditions Automatically when Shooting (Auto Bracket)

Shooting in Exposure Bracket Mode

You can take continuous pictures with different exposure when the shutter release button is pressed. The first frame is exposed with no compensation, the second frame is underexposed (negative compensation) and the third is overexposed (positive compensation) (when the number of frames is set to [3]).



Normal exposure



Underexposure



Overexposure

You can set [9. Auto Bracketing order] in the [C Custom Setting] menu.

Auto Bracketing order

0 → - → +, - → 0 → +, + → 0 → -, 0 → + → -

1 Set the number of frames.

Turn the front e-dial while pressing the  button. Select OFF (no frames), 3 or 5.

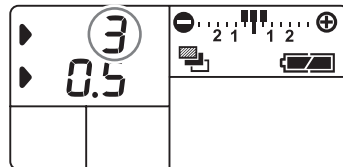
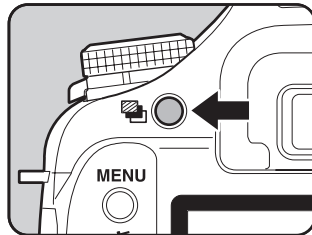

2 Set the step interval.

Turn the rear e-dial while pressing the  button. The available bracketing amounts in [2. EV Steps] in the [C Custom Setting] menu (p.73) are as follows.

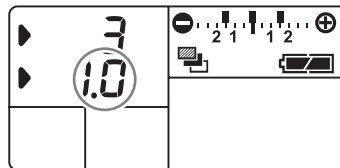

Bracketing amount (Step interval)	1/2 EV	$\pm 0.5, \pm 1.0, \pm 1.5, \pm 2.0$
	1/3 EV	$\pm 0.3, \pm 0.7, \pm 1.0, \pm 1.3, \pm 1.7, \pm 2.0$

3 Press the shutter release button halfway.

The focus indicator  appears in the viewfinder when focused.

4 Press the shutter release button fully.

Three continuous pictures will be taken, the first with no compensation, the second with negative compensation, and the third with positive compensation (when the number of frames is set to [3]).



- When the focus mode is set to **A.F.S.** (Single mode), the focus is locked in the first frame position and used for subsequent continuous frames.
- When you release your finger from the shutter release button during Auto Bracket, the Auto Bracket exposure setting will remain effective for twice as much time as the exposure metering timer (default setting is 20 seconds) (p.99) and you can take a picture at the next compensation value. In this case, auto focusing works for each frame. After about twice as much time as the exposure metering timer (default setting is 20 seconds), the camera returns to settings for taking the first picture.
- You can combine Auto Bracket with the built-in flash or external flash (P-TTL auto only) to change only the flash output continuously. However, when using an external flash, holding the shutter release button down to take three continuous frames may cause the second and third frame to be taken before the flash is fully recharged. Always take one frame at a time after confirming that charging is complete.
- Exposure Bracket is not available when the exposure mode is set to **B** (Bulb) mode.
- Exposure Bracket and Multi-exposure cannot be used together. The mode set last is used.
- When [8. One-Push Bracketing] in the [C Custom Setting] menu is set to [On], even if the shutter release button is not continuously pressed fully, all frames are automatically shot with one press of the shutter release button.

Taking Only Overexposed or Underexposed Pictures

You can use Auto Bracket mode for only underexposure or overexposure shots by combining the operation with EV compensation (p.100). Auto Bracket is performed in both cases on the basis of the specified EV compensation value.

Shooting in Extended Bracket Mode

You can save pictures with three different white balance, saturation, hue, sharpness and contrast levels.

Unlike exposure bracketing, three pictures are saved with each shot. You can set the saving order with [9. Auto Bracketing order] in the [C Custom Setting] menu.

Auto Bracketing order	0 → - → +, - → 0 → +, + → 0 → -, 0 → + → -
-----------------------	--

- 1 Select [Extended Bracket] in the [Rec. Mode] menu and press the four-way controller (▶).

The Extended Bracket screen appears.

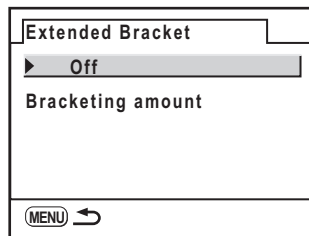

- 2 Press the four-way controller (▶).

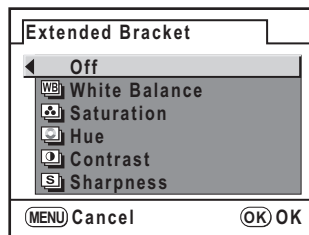

- 3 Use the four-way controller (▲ ▼) to choose an item.

- 4 Press the OK button.

5 Press the four-way controller (▼) to select [Bracketing amount] and press the four-way controller (▶).

Use the four-way controller (▲▼) to select the bracketing amount.

For [White Balance], select from BA±1, BA±2, BA±3, GM±1, GM±2 and GM±3. The default setting is BA±1.

For [Saturation], [Hue], [Contrast] and [Sharpness], select from ±1, ±2, ±3 and ±4. The default setting is ±1.

6 Press the OK button twice.

7 Press the MENU button.

The camera returns to the Capture mode.

8 Take the picture.

Three frames are saved.



- You can use Extended Bracket in combination with Exposure Bracket (p.129).
- Extended Bracket and Multi-exposure cannot be used together. The mode set last is used.
- Extended Bracket is disabled when File Format is set to RAW or RAW+.
- If Extended Bracket is set when File Format is set to RAW or RAW+, the file format changes to JPEG.
- When Image Tone for Custom Image is set to [Monochrome], bracket shooting with [Saturation] and [Hue] is not available.

Storing User Settings

You can store the current camera settings and easily retrieve them simply by setting the mode dial to **USER**.

The following settings can be stored.

Exposure Mode	Auto Sensitivity Adjustment Range
Flash Mode	White Balance
EV Compensation	Color Space
Exposure Bracketing Steps & No. of Frames	File Format
Drive Mode	JPEG Recorded Pixels
Flash Exposure Compensation	JPEG Quality
Extended Bracketing Steps & Type	Expand Dynamic Range
Sensitivity	RAW file format

Store the settings in [USER] in the [Set-up] menu.

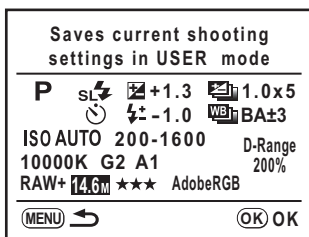

Changing the Settings in USER Mode

You can also perform settings when the mode dial is set to **USER**.

To change the Exposure Mode, press the **MENU** button in Capture mode and perform settings in [Exposure Mode] in the [USER] menu.

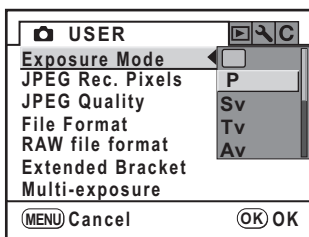

Changed settings are not saved unless they are registered in [USER] in the [Set-up] menu. When the camera is turned off, the saved settings are applied.

Memo



5 Using the Flash

This chapter provides details on the built-in flash of *K20D* and describes how to take pictures with the external flash.

Compensating Flash Output	136
Allowing Shooting while Charging Flash	137
Flash Characteristics in Each Exposure Mode	138
Distance and Aperture when Using the Built-in Flash	141
DA, D FA, FA J, FA and F Lens Compatibility with the Built-in Flash	142
Using an External Flash (Optional)	143

Compensating Flash Output

You can change the flash output in a range of -2.0 to $+1.0$. The flash compensation values are as follows for $1/2$ EV and $1/3$ EV.

Step interval	Flash compensation
$1/2$ EV	$-2.0, -1.5, -1.0, -0.5, 0.0, +0.5, +1.0$
$1/3$ EV	$-2.0, -1.7, -1.3, -1.0, -0.7, -0.3, 0.0, +0.3, +0.7, +1.0$

* Set interval of steps in [2. EV Steps] in the [C Custom Setting] menu. (p.101)

Turn the rear e-dial to set [Flash Mode] in the Fn menu (p.75).

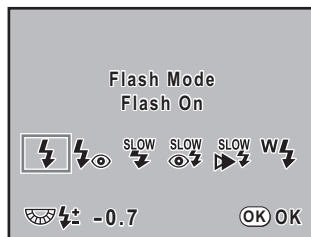

5

Using the Flash



- The flash output cannot be compensated in Green mode.
- appears in the LCD panel and the viewfinder during flash exposure compensation. (p.27)
- If the maximum flash output is exceeded when corrected to the plus (+) side, no compensation will be effective.
- Compensating to the minus (–) side may not effect the image if the subject is too close, aperture is low or sensitivity is high.
- This flash compensation is also effective for external flash units which support P-TTL auto flash mode.
- Pressing the Green button on the [Flash Mode] menu returns the flash exposure compensation to the default setting (0.0).

Allowing Shooting while Charging Flash

137

You can set to enable shooting while flash is being charged.
Set [On] for [28. Release when Charging] in the [C Custom Setting] menu (p.74). Pictures cannot be taken while the flash is charging by default.

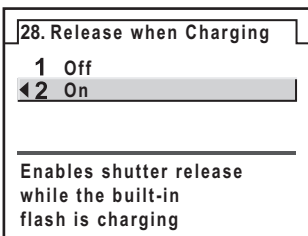

5

Using the Flash

Flash Characteristics in Each Exposure Mode

Using the Flash in Tv (Shutter Priority) Mode

- When taking a moving subject, you can use the flash to change the blur effect.
- Any desired shutter speed 1/180 sec. or slower can be set for taking a flash photograph.
- The aperture value automatically changes according to the ambient brightness.
- The shutter speed is locked at 1/180 sec. when lens other than DA, D FA, FA J, FA, F or A is used.

Using the Flash in Av (Aperture Priority) Mode

5

Using the Flash

- You can set the desired aperture to take a flash photograph when you want to change the depth of field or shoot a subject farther away.
- The shutter speed automatically changes with the ambient brightness.
- The shutter speed shifts automatically anywhere from 1/180 sec. to a slow shutter speed (p.54) that reduces camera shake. The slowest shutter speed depends on the focal length of the lens in use.
- The shutter speed is locked at 1/180 sec. when lens other than DA, D FA, FA J, FA or F is used.



Using the Slow-Speed Sync

You can use slow-speed sync when shooting portraits with the sunset in the background. Both the portrait and the background are captured beautifully.





- Slow-speed sync slows the shutter speed. Use the Shake Reduction function or turn off the Shake Reduction function and use a tripod to avoid camera shake. The picture will also blur if the subject moves.
- Slow-speed sync shooting can also be performed with an external flash.

● Using P/Sv/Av mode

- 1 Set the mode dial to **P**, **Sv** or **Av**.
- 2 Press the **⚡UP** button.
- 3 Press the **Fn** button and press the four-way controller (▼).
- 4 Select  or  and press the **OK** button.
The shutter speed is set slower to give the appropriate exposure for the background.
- 5 Take the picture.

● Using Tv/TAv/M mode

- 1 Set the mode dial to **Tv**, **TAv** or **M**.
- 2 Press the **Fn** button and press the four-way controller (▼).
- 3 Select  or  and press the **OK** button.
- 4 Set the shutter speed (**Tv**) or shutter speed and aperture (**TAv/M**).
Set so that proper exposure is obtained in 1/180 sec. or slower.
- 5 Press the **⚡UP** button.
- 6 Take the picture.

Using Trailing Curtain Sync

Trailing curtain sync discharges the flash immediately before the shutter curtain closes. When shooting moving objects with a slow shutter speed, Trailing curtain sync and Slow-speed sync produce different effects depending on when the flash is discharged.

For example, when shooting a moving car with Trailing curtain sync, trailing light is captured while the shutter is open and the flash captures the car immediately before the shutter is closed. Therefore, the picture will include a sharp, well-lit car with trailing lights behind it.

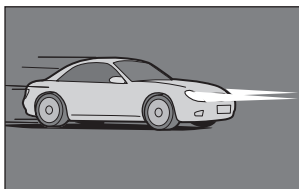

Slow-speed sync

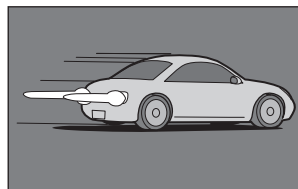

Trailing curtain sync

5

Using the Flash

- 1 Set the mode dial to any mode other than **■** or **X**.
- 2 Press the **Fn** button and press the four-way controller (**▼**).
- 3 Select **▶^{SLOW}⚡** or **▶⚡** and press the **OK** button.
- 4 Press the **⚡UP** button.
- 5 Take the picture.



Trailing curtain sync slows the shutter speed. Turn off the Shake Reduction function and use a tripod to avoid camera shake.

Distance and Aperture when Using the Built-in Flash

A set criteria is necessary between the guide number, aperture and distance when shooting with the flash to obtain the correct exposure. Calculate and adjust the shooting conditions if flash output is not sufficient.

Built-in flash guide number

ISO Sensitivity	Built-in flash guide number
ISO 100	13
ISO 200	18.4
ISO 400	26
ISO 800	36.8
ISO 1600	52
ISO 3200	73.5

Calculating Shooting Distance from Aperture Value

The following equation calculates the distance of the flash for aperture values.

Maximum flash distance $L1 = \text{Guide number} \div \text{Selected aperture}$

Minimum flash distance $L2 = \text{Maximum flash distance} \div 5^*$

* The value 5 used in the formula above is a fixed value which applies only when using the built-in flash alone.

Example

When sensitivity is [ISO 100] and aperture value is F2.8

$L1 = 13 \div 2.8 = \text{approx. } 4.6 \text{ (m)}$

$L2 = 4.6 \div 5 = \text{approx. } 0.9 \text{ (m)}$

Therefore, the flash can be used in a range of about 0.9 m to 4.6 m.

The flash cannot be used when the distance is 0.7 m or less. When the flash is used at closer than 0.7 m, it causes vignetting in the picture corners, light is distributed unevenly and the picture may be over-exposed.

Calculating Aperture Value from Shooting Distance

The following equation calculates the aperture value for shooting distances.

Aperture value used $F = \text{Guide number} \div \text{Shooting distance}$

Example

When sensitivity is [ISO 100] and shooting distance is 3 m, aperture value is:

$F = 13 \div 3 = 4.3$

If the resulting number (4.3, in the above example) is not available as a lens aperture, the smaller number that is closest (4.0, in the above example) is generally used.

DA, D FA, FA J, FA and F Lens Compatibility with the Built-in Flash

Depending on the lens used with the **K20D**, even if a lens without a hood is attached, the use of the built-in flash may not be possible or may be limited due to vignetting.

DA, D FA, FA J, and FA lenses not listed below can be used without problems.

* Following are evaluated without a hood.

Unavailable due to vignetting

Lens Name
DA Fish-eye 10-17mm F3.5-4.5ED (IF)
DA12-24mm F4ED AL
DA14mm F2.8ED (IF)
FA★300mm F2.8ED (IF)
FA★600mm F4ED (IF)
FA★250-600mm F5.6ED (IF)

Available depending on other factors

Lens Name	Compatibility
F Fish-eye 17-28mm F3.5-4.5	Vignetting may occur if focal length is less than 20 mm.
DA16-45mm F4ED AL	When the focal length is less than 28 mm or when the focal length is 28 mm and the shooting distance is 1 m or less, vignetting may occur.
DA★16-50mm F2.8ED AL (IF) SDM	When the focal length is 20 mm or less or when the focal length is 35 mm and the shooting distance is less than 1.5 m, vignetting may occur.
DA18-250mm F3.5-6.3ED AL (IF)	Vignetting may occur if the focal length is less than 35 mm.
FA★28-70mm F2.8AL	Vignetting may occur if focal length is 28 mm and the shooting distance is less than 1 m.
FA Soft 28mm F2.8	Built-in flash always discharges fully.
FA Soft 85mm F2.8	Built-in flash always discharges fully.

Using an External Flash (Optional)

Using the optional external flash AF540FGZ, AF360FGZ or AF200FG enables a variety of flash modes, such as P-TTL auto flash mode, depending on the external flash being used. See the chart below for details.

(Yes: Available #: Restricted No: Not available)

Camera Function \ Flash	Built-in Flash	AF540FGZ AF360FGZ	AF200FG
Red-eye reduction flash	Yes	Yes	Yes
Automatic flash discharge	Yes	Yes	Yes
After the flash is charged, the camera automatically switches to the flash sync speed.	Yes	Yes	Yes
Aperture is automatically set in P (Hyper-program) mode and Tv (Shutter Priority) mode.	Yes	Yes	Yes
Auto check in the viewfinder	No	No	No
P-TTL auto flash (appropriate sensitivity: 100 to 1600)	Yes* ¹	Yes* ¹	Yes* ¹
Slow-speed sync	Yes	Yes	Yes
Flash exposure compensation	Yes	Yes	Yes
AF illuminator	Yes	Yes	No
Trailing curtain sync* ²	Yes	Yes	No
Contrast-control-sync flash mode	#* ³	Yes	#* ⁵
Slave flash	No	Yes	No
Multiple flash	No	No	No
High-speed flash sync	No	Yes	No
Wireless flash	#* ⁵	Yes* ⁴	No

*¹ When using DA, D FA, FA J, FA, F or A lens.

*² Shutter speed of 1/90 sec. or slower.

*³ When combined with the AF540FGZ or AF360FGZ, 1/3 of the flash discharge can be output by the built-in flash and 2/3 can be output by the external flash.

*⁴ Multiple AF540FGZ or AF360FGZ units or a combination of an AF540FGZ/AF360FGZ unit and the built-in flash is required.

*⁵ Only available when combined with the AF540FGZ or AF360FGZ.

About the LCD Panel Display for AF360FGZ

The AF360FGZ does not have the function to set the FORMAT size to [DIGITAL], but the difference in angle of view between standard 35 mm format and the **K20D** is automatically calculated based on the focal length of the lens used (when using DA, D FA, FA J, FA or F lenses). The conversion indicator appears and the format size indicator disappears when the exposure metering timer of the **K20D** is on (it returns to 35 mm format display when the exposure metering timer is turned off).

Lens focal length		85mm	77mm	50mm	35mm	28mm	24mm	20mm	18mm
AF360FGZ LCD panel	Exposure metering timer Off	85mm	70mm	50mm	35mm	28mm	24mm	20mm	18mm
	Exposure metering timer On	58mm	48mm	34mm	24mm	19mm	16mm*	14mm*	12mm*

* Using wide-angle panel

5

Using the Flash

Using P-TTL Auto Mode

Use this flash mode with the AF540FGZ, AF360FGZ or AF200FG flash unit. When flash mode is set to [P-TTL auto], the flash pre-flashes before the actual flash and confirms the subject (the distance, brightness, contrast, whether it is backlit, etc.) using the camera's 16-segment metering sensor. The flash output for the actual flash is adjusted based on the information obtained from the pre-flash, enabling flash photography with more appropriate exposure for the subject than with normal TTL auto. P-TTL auto is available in wireless flash mode when two or more AF540FGZ or AF360FGZ units are used.

- 1 Remove the cover of the hot shoe and attach the external flash (AF540FGZ or AF360FGZ).
- 2 Turn on the camera and the external flash.
- 3 Set the external flash mode to [P-TTL auto].
- 4 Confirm that the external flash is fully charged and then take the picture.



- P-TTL auto is only available with the AF540FGZ, AF360FGZ or AF200FG flash unit.
- The will light in the viewfinder when the flash is ready (fully charged).
- For details such as operation method and effective distance, please read the external flash manual.
- The flash does not discharge when the subject is bright enough when Flash Mode is or . Therefore, it may not be suitable for daylight-sync shooting.
- Never press the button when any external flash unit is attached to the camera. The built-in flash will hit the external flash. If you want to use both at once, see p.149 for the connection method.

Using High-Speed Flash Sync Mode

With the AF540FGZ or AF360FGZ, you can discharge the flash to take a picture at a shutter speed faster than 1/180 second. High-speed flash sync can be used with the flash attached to the camera, or wireless.

Attaching and Using the AF540FGZ or AF360FGZ on the Camera

- 1 Remove the cover of the hot shoe and attach the external flash (AF540FGZ or AF360FGZ).
- 2 Turn the mode dial and set the exposure mode to **Tv** or **M**.
- 3 Turn on the camera and the external flash.
- 4 Set the external flash sync mode to HS (high-speed flash sync).
- 5 Confirm that the external flash is fully charged and then take the picture.



- The will light in the viewfinder when the flash is ready (fully charged).
- High-speed flash sync is only available when the shutter speed is faster than 1/180 sec.
- High-speed flash sync is not available when the exposure mode is set to **B** (Bulb).

Using in Wireless Mode

By using two external flashes (AF540FGZ or AF360FGZ) or using the built-in flash with an external flash, you can shoot in P-TTL flash mode without connecting the flash units with a cord. High-speed sync mode is also available for wireless shooting.



- Set the power switch of the external flash to [WIRELESS].
- Set the wireless mode of the external flash not directly connected to the camera to [SLAVE].

Setting the Channel for the External Flash on the Camera

First set the channel for the external flash unit on the camera.

- 1 Set the channel for the external flash unit.
- 2 Attach the external flash to the camera hot shoe.
- 3 Turn on the camera and the external flash, and press the shutter release button halfway.

The built-in flash is set to the same channel as the external flash unit.



- When set to **w** mode, the channel currently set for the built-in flash is displayed on the LCD panel for 10 seconds.
- Be sure to set all the flashes to the same channel. Refer to the AF540FGZ or AF360FGZ operating manual for details on how to set the channel on the external flash.

Using the Built-in Flash Wirelessly

5

Using the Flash

Set the camera to wireless flash mode when using an external flash in combination with the built-in flash.

- 1 Press the **Fn** button and press the four-way controller (▼).
The Flash options screen appears.
- 2 Use the four-way controller (◀▶) to select **w** mode.
Press the **OK** button to return to Capture mode.

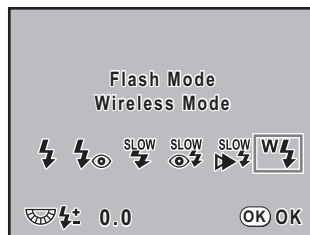

- **w** cannot be set in **■** mode.
- When Drive Mode is set to **i**_{as} or the lens aperture is not set to **A**, **w** appears gray and cannot be selected.

● Changing the Built-in Flash Discharge Method

You can change the built-in flash discharge method in wireless mode.

1	On	Discharges the built-in flash.
2	Off	Discharges the built-in flash as a test flash.

Set in [29. Flash in Wireless Mode] in the [C Custom Setting] menu.



HS  (High-speed sync) is not available when the camera is set to discharge the built-in flash.

Wireless Shooting

● Using a Combination of the Built-in Flash and an External Flash Unit

- 1 Remove the external flash unit for which the channel was set on the camera, and place at the desired location.
- 2 Set the flash mode of the camera to , and pop up the built-in flash.
- 3 Confirm that both flashes are fully charged and then take the picture.

● Using a Combination of External Flash Units

- 1 Set the wireless mode of the external flash directly connected to the camera to [MASTER] or [CONTROL].

MASTER	Discharges both the flash directly connected to the camera and the wireless flash unit.
CONTROL	The flash directly connected to the camera is discharged as a test flash only and does not discharge as main flash.

- 2 On the wireless flash unit, set the wireless flash mode to [SLAVE] and set the channel to the same channel as the camera. Then, place at the desired location.
- 3 Confirm that both flashes are fully charged and then take the picture.



Shake Reduction is not available in Wireless mode.

Wireless Flash Control (P-TTL Flash Mode)

When using external flash units (AF540FGZ or AF360FGZ) for wireless shooting, the following information is exchanged between the flash units before the flash is discharged.

Press the shutter release button fully.

- 1 The flash unit directly connected to the camera emits a test flash (relays the flash mode of the camera).
- 2 The wireless flash unit emits a test flash (relays confirmation of subject).
- 3 The flash unit directly connected to the camera emits a test flash (relays flash output to the wireless flash unit).
 - * The flash unit directly connected to the camera will emit a test flash one more time after this to relay the flash duration time when HS ⚡ (Highspeed sync) is set.
- 4 The wireless flash unit discharges as main flash.



When the wireless mode of the external flash on the camera is set to [MASTER] or [29. Flash in Wireless Mode] (p.146) is set to [On] for the built-in flash, all the flash units will discharge simultaneously.

Red-Eye Reduction

As with the built-in flash, red-eye reduction is available with an external flash. This may not be available on some flashes or may have restrictions for usage conditions. See the chart on p.143.



- The red-eye reduction feature works even when only an external flash is used. (p.64)
- If red-eye reduction of the built-in flash is used when the external flash is set as the slave unit or with the wireless function, the preflash for red-eye reduction will trigger the external flash. Do not use red-eye reduction when using a slave unit.

Trailing Curtain Sync

When using the built-in flash with an external flash (AF540FGZ or AF360FGZ) that is set to the Trailing curtain sync function, the built-in flash will also use this mode. Confirm that both flash units are fully charged before shooting.

Using the Built-in Flash with the External Flash

As shown in the illustration below, attach the Hot Shoe Adapter F_G (optional) to the camera hot shoe and an Off-Camera Shoe Adapter F (optional) to the bottom of the external flash, and connect these with the Extension Cord F5P (optional). The Off-Camera Shoe Adapter F can be mounted using the tripod screw to your tripod. Only the P-TTL auto flash can be used in combination with the built-in flash.

When combining with the built-in flash

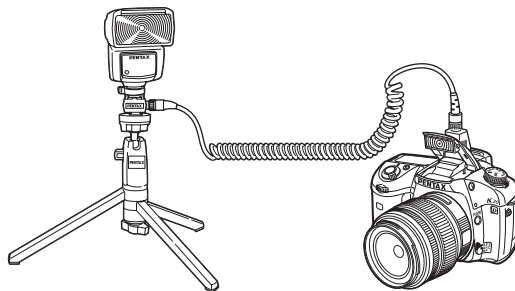

Discharging Multiple Flashes

You can combine two or more external flashes (AF540FGZ, AF360FGZ or AF200FG) or you can use two or more external flashes in combination with the built-in flash. You can use the extension cord connection terminal on the flash to connect the AF540FGZ. You can connect AF360FGZ or AF200FG units as shown in the illustration below. Connect an external flash and the Hot Shoe Adapter F (optional) to the Off-Camera Shoe Adapter F (optional) and then connect another Off-Camera Shoe Adapter F with external flash using the Extension Cord F5P (optional). Refer to the flash manual for details.



- Do not combine with accessories that have a different number of contacts such as a Hot Shoe Grip as a malfunction may occur.
- Combining with flashes from other manufacturers may cause equipment breakdown. We recommend using the AF540FGZ, AF360FGZ or AF200FG.

When combining two or more external flashes

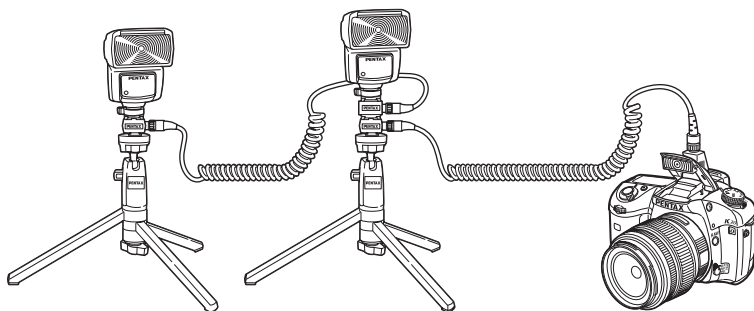

When using multiple external flashes or an external flash with the built-in flash, P-TTL is used for flash control.

Contrast-Control-Sync Flash

5

Using the Flash

Combining two or more external flashes (AF540FGZ, AF360FGZ or AF200FG) or using an external flash in combination with the built-in flash allows multiple flash photography (contrast-control-sync flash photography). This is based on the difference between the amounts of light discharged from multiple units.



- The AF200FG must be combined with the AF540FGZ or AF360FGZ.
- Do not combine with accessories that have a different number of contacts such as a Hot Shoe Grip as a malfunction may occur.
- Combining with flashes from other manufacturers may cause equipment breakdown. We recommend using PENTAX automatic flashes.

- 1 Connect the external flash to the camera indirectly. (p.149)
- 2 Set the sync mode for the external flash to the Contrast-Control-Sync mode.
- 3 Turn the mode dial and set the exposure mode to **P**, **Tv**, **Av** or **M**.
- 4 Confirm that both the external flash and built-in flash are fully charged and then take the picture.



- When using two or more external flashes and the Contrast-Control-Sync mode is set on the external master flash unit, the flash output ratio is 2 (master unit) : 1 (slave units). When external flash is used in combination with the built-in flash, the flash output ratio is 2 (external flash) : 1 (built-in flash).
- When using multiple external flashes or an external flash with the built-in flash, P-TTL is used for flash control.

X-sync Socket

You can connect an external flash to the camera with a sync cord by using the X-sync socket.

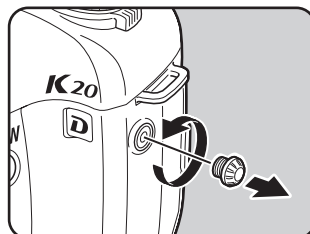

- The use of high-voltage or high-current external flashes may cause a camera breakdown.
- When a cord is connected to the X-sync socket, linked functions will not work.
- To prevent vignetting caused from Trailing curtain sync, it is recommended to take a test shot using a shutter speed one level slower than the flash sync speed.
- The contact of the X-sync socket is not splash and dust resistant. Attach the provided Sync socket 2P cap when not in use.

Memo



6 Shooting Settings

This chapter describes how to set the save format for pictures taken and other settings.

Setting the Image Processing Method in Capture Mode (Custom Image)	154
Setting the File Format	156

Setting the Image Processing Method in Capture Mode (Custom Image)

By using Custom Image to change the [Image Tone], you can adjust settings such as the color and contrast before shooting an image.

Select from the following six modes for Image Tone: Bright, Natural, Portrait, Landscape, Vibrant and Monochrome.

The default setting varies depending on the [Language/言語] setting (p.224), and it may be set to [Natural].

You can adjust the following items for Image Tone.

Saturation ^{*1}	Sets the color saturation. (Available settings: -4 to +4)
Hue ^{*1}	Sets the color. (Available settings: -4 to +4)
Filter Effect ^{*2}	Changes the contrast to appear as if a B&W color filter was used. Sets the filter color. (Available settings: [None], [Green], [Yellow], [Orange], [Red], [Magenta], [Blue], [Cyan], [Infrared Color])
Toning ^{*2}	Sets the level for cold tone adjustment (- direction) and warm tone adjustment (+ direction). (Available settings: -4 to +4)
Contrast	Sets the image contrast. (Available settings: -4 to +4)
Sharpness	Set the sharpness of the image outlines. (Available settings: -4 to +4)

*1 This can be set when any mode other than [Monochrome] is selected.

*2 This can be set when [Monochrome] is selected.

1 Press the Fn button in Capture mode.

The shooting Fn menu appears.

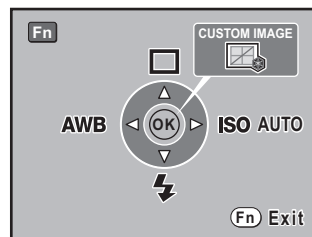

2 Press the OK button.

The Custom Image screen appears. After the power is turned on, the last image taken is displayed in the background. Set the main switch to  to change the background image to the Digital Preview image.

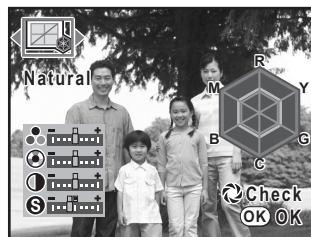

3 Use the four-way controller (◀▶) to choose the Image Tone.

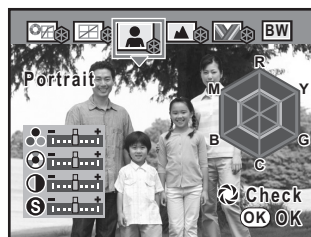

4 Use the four-way controller (▲▼) to choose the item you want to change ([Saturation], [Hue], [Contrast], [Sharpness]).

When Image Tone is set to [Monochrome], you can change the settings for [Filter Effect], [Toning], [Contrast], and [Sharpness].

5 Use the four-way controller (◀▶) to change the setting.

The background image changes according to the setting. You can visually check the saturation and hue with the radar chart. For [Sharpness], turn the rear e-dial toward  to change the setting to [Fine Sharpness]. The image outlines are even thinner and sharper with [Fine Sharpness], making it suited for capturing fine subjects such as hair.

6 Press the OK button.

The camera returns to the Capture mode.



You can save the background image with the current settings as a JPEG image. Press the **Fn** button to display the image save confirmation screen, and then select [Save as] and press the **OK** button.

Setting the File Format

Setting the JPEG Recorded Pixels

You can select the number of recorded pixels from **14.6M**, **10M**, **6M** and **2M**. The more pixels there are, the larger the picture and the bigger the file size. The file size will also differ according to the [JPEG Quality] setting. The default setting is **14.6M** 4672×3104.

14.6M	4672×3104	14"×17" / A2 paper
10M	3872×2592	10"×12" / A3 paper
6M	3008×2000	8"×10" / A4 paper
2M	1824×1216	5"×7" / A5 paper

The paper sizes above are references for optimal printing by recorded pixels. The quality of the captured photo or printed picture depends on the quality level, exposure control, resolution of the printer and a variety of other factors.

You can set the JPEG recorded pixels in [JPEG Recorded Pixels] in the [Rec. Mode] menu. (p.72)

When the number of recorded pixels is changed, the number of recordable images appears at the top right of the screen.

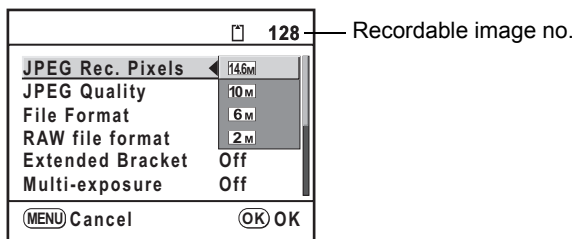

Setting the JPEG Quality Level

You can set the image quality level. The file size will also differ according to the [JPEG Rec. Pixels] setting. The default setting is ★★★ (Best).

Z	Premium	 Images will be clearer but file size will be larger.
★★★	Best	
★★	Better	
★	Good	

You can set the JPEG quality level in [JPEG Quality] in the [📷 Rec. Mode] menu. (p.72)

When the quality level is changed, the number of recordable images at that quality level appears at the top right of the screen.

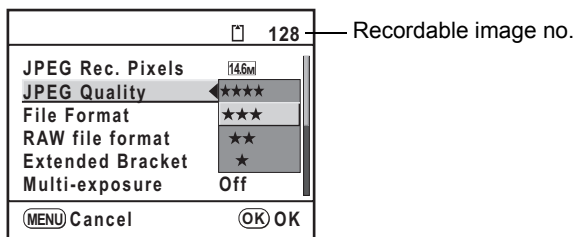

Setting the File Format

You can set the format of image files. The default setting is JPEG.

JPEG	Captures images in JPEG format. You can change the number of recorded pixels from [JPEG Rec. Pixels] in the [📷 Rec. Mode] menu, and the image quality level from [JPEG Quality] in the [📷 Rec. Mode] menu. The file size varies according to the settings.
RAW	RAW data is CMOS sensor output data saved without processing. Effects such as White Balance, Custom Image and Color Space are not applied to the image but such information is saved. Use Raw Display (p.197) or transfer to a PC, apply effects with the enclosed PENTAX PHOTO Laboratory 3 and create JPEG or TIFF images.
RAW+	Image is saved in both RAW and JPEG formats. When the RAW button is pressed, images are temporarily captured in both formats. (p.19)

Set [File Format] in the [📷 Rec. Mode] menu. (p.72)

When the file format is changed, the number of recordable images appears at the top right of the screen.

You can select PEF or DNG format in [RAW file format] in the [📷 Rec. Mode] menu when images are captured in RAW format. The default setting is PEF format.

PEF: PENTAX original RAW file format

DNG: General-purpose, publicly available RAW file format designed by Adobe Systems

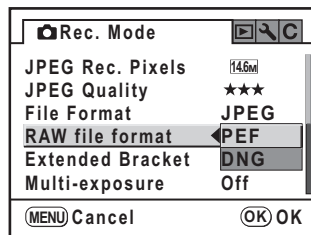
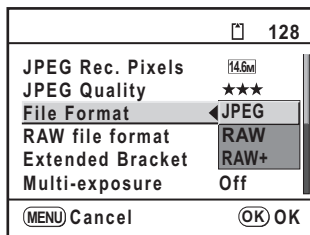

Setting the RAW Button Function

You can set the function when the **RAW** button (p.19) is pressed. The following settings are available.

Cancel each time	<input checked="" type="checkbox"/> (On)/ <input type="checkbox"/> (Off)
File Format	File format selected when the RAW button is pressed.

1 Select [RAW Button] in the [**Rec. Mode**] menu.

2 Press the four-way controller (▶).

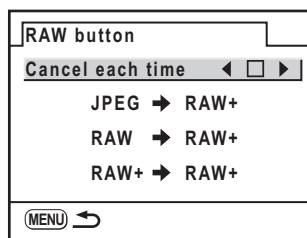

3 Use the four-way controller (◀▶) to select (On) or (Off) for [Cancel each time].

When set to (On), the recording format each time a picture is taken returns to the [File Format] setting in the [**Rec. Mode**] menu. The default setting is (On).

4 Use the four-way controller (▲▼) to choose a file format.

The left side is the [File Format] setting in the [**Rec. Mode**] menu and the right side is the file format when the **RAW** button is pressed.

5 Press the four-way controller (▶), and use the four-way controller (▲▼) to select the file format when the **RAW** button is pressed.







6 Press the OK button.

7 Press the **MENU** button twice.

The camera returns to the Capture or Playback mode.

Setting the White Balance

White balance is a function for adjusting the color of an image so that white objects appear white. Set the white balance if you are not satisfied with the color balance of pictures taken with white balance set to **AWB** (Auto), or to intentionally apply a creative effect to your images. The default setting is **AWB** (Auto).

AWB	Auto	Automatically adjusts the white balance. (About 4000 to 8000K)
	Daylight	For use when taking pictures in sunlight. (About 5200K)
	Shade	For use when taking pictures in the shade. It reduces the bluish color tones in a picture. (About 8000K)
	Cloudy	For use when taking pictures on cloudy days. (About 6000K)
	Fluorescent Light	For use when taking pictures under fluorescent lighting. Select the type of fluorescent light, from W (white) (about 4200K), N (neutral white) (about 5000K), and D (daylight) (about 6500K).
	Tungsten Light	For use when taking pictures under light bulb or other tungsten light. It reduces the reddish color tones in a picture. (About 2850K)
	Flash	For use when taking pictures using the built-in flash. (About 5400K)
	Manual	Use this to manually adjust the white balance according to the lighting so that white objects appear as a natural white.
K	Color Temperature	Use figures to set the color temperature. You can save three settings.

* The color temperature (K) is an estimate. This does not indicate precise colors.

1 Press the Fn button.

The Fn menu appears.

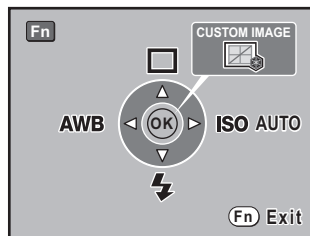

2 Press the four-way controller (◀).

The White Balance screen appears.

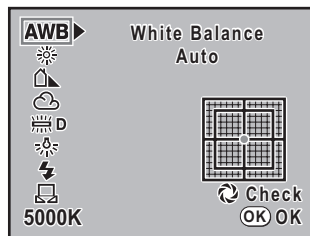

3 Press the four-way controller (▲▼) and set.

Set the main switch to  to display Digital Preview with the set White Balance.

Fine-tuning White Balance is easier with Digital Preview.

Press the **Fn** button to save the background Digital Preview image.

4 Press the OK button.

The camera is ready to take a picture with the set White Balance.



- Refer to p.163 for manual adjustment method.
- Preview is Digital Preview, regardless of the [30. Preview Method] setting in the [C Custom Setting] menu.
- The camera automatically performs fine-tuning even when the light source is specified. The color temperature of the light source is fixed when [12. WB Adjustable Range] in the [C Custom Setting] menu is set to [Fixed].
- Because the light source changes when the flash discharges, you can set the white balance for when the flash discharges. Select [AWB], [Unchanged] or [Flash] in [11. WB when using flash] in the [C Custom Setting] menu.

Fine-Tuning the White Balance

The **K20D** allows you to fine tune the White Balance setting.

1 Perform desired settings in Steps 1 to 3 of “Setting the White Balance”.

2 Press the four-way controller (▶).

The White Balance fine tune screen appears.

3 Use the four-way controller (▲▼◀▶) to fine tune White Balance.

Seven levels and 225 patterns are available on the G-M and B-A axes.

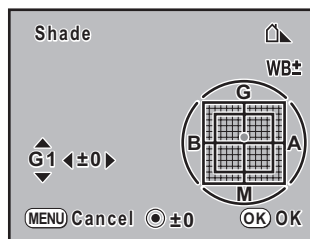

GM compensation	Adjusts the tone of the colors between green and magenta.	▲▼
BA compensation	Adjusts the tone of the colors between blue and amber.	◀▶

Press the Green button to reset the GM compensation and BA compensation.

4 Press the OK button.

The camera returns to the White Balance screen.

5 Press the OK button.

The camera is ready to take a picture with the set White Balance.

Adjusting the White Balance Manually

You can adjust the white balance depending on the light source when taking pictures. With Manual White Balance, the camera can store delicate shades that cannot be precisely adjusted with the white balance preset values provided in the camera (p.160). This provides the optimum white balance for your surroundings.

1 Press the Fn button.

The Fn menu appears.

2 Press the four-way controller (◀).

The White Balance screen appears.

3 Use the four-way controller (▼) to select (Manual).

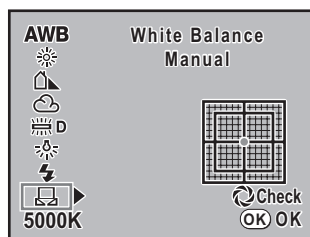

4 Press the four-way controller (▶).

The White Balance fine tune screen appears.

5 Under the light to adjust the white balance, fully display a white sheet of paper in the viewfinder or select a white area as the subject.

6 Press the shutter release button fully.

Slide the focus mode lever to **MF** when the shutter cannot be released.

The screen to select the measuring range is displayed.



7 Use the rear e-dial to select the entire screen or spot area for the measuring range.

8 When a spot area is selected, use the four-way controller (▲▼◀▶) to move the frame to the area you want to measure.

9 Press the OK button.

The White Balance fine-tuning screen appears when measuring is completed.

Tune using steps in “Fine-Tuning the White Balance” if fine-tuning is necessary. (p.162)

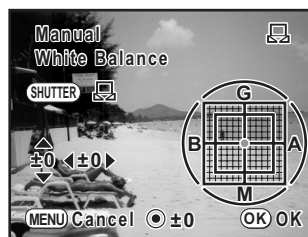

10 Press the OK button.

The camera returns to the White Balance screen.

11 Press the OK button.

The camera is ready to take a picture with the set White Balance.



- No image is recorded when the shutter release button is pressed to adjust the white balance. Press the **Fn** button to save the background image as a JPEG image. The image save confirmation screen appears. Select [Save as] and press the **OK** button.
- [NG] appears when measuring is unsuccessful. Press the **OK** button while displayed to return to the White Balance fine tune screen for remeasuring.
- If the picture is extremely overexposed or underexposed, white balance may not be adjusted. In this case, adjust appropriate exposure and adjust the white balance.

Adjusting the White Balance with Color Temperature

Use figures to set the color temperature.

1 Press the Fn button.

The Fn menu appears.

2 Press the four-way controller (◀).

The White Balance screen appears.

3 Use the four-way controller (▼) to select Color Temperature (the default setting is 5000K).

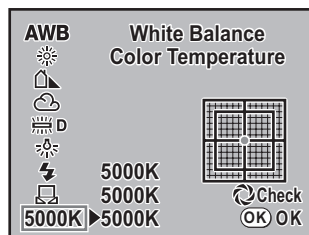

4 Press the four-way controller (▶).

5 Use the four-way controller (▲▼) to select the Color Temperature to change.

You can save three settings. Settings are saved to the location selected here. Additionally, perform the same operations to change Color Temperature that has already been set.

6 Press the four-way controller (▶).

The screen to enter the color temperature appears.

7 Adjust the Color Temperature with the front and rear e-dial.

Color Temperature steps differ depending on the e-dial.

	Kelvin	Mired*
Front e-dial	1 Step (100K)	1 Step (20M)
Rear e-dial	10 Steps (1000K)	5 Steps (100M)

* The default setting for Color Temperature step units is Kelvin. You can change the step units to Mired in [19. Color temp. steps] in the [C Custom Setting] menu. However, figures are converted to Kelvin and displayed.

You can also use the steps for "Fine-Tuning the White Balance" (p.162) to fine tune.

8 Press the OK button.

The settings are saved and the camera returns to the White Balance screen. Set the main switch to  to display Digital Preview with the set Color Temperature.

9 Press the OK button.

The camera is ready to take a picture with the set White Balance.

Color Temperature

The color of light shifts towards blue as the color temperature rises, and towards red as the color temperature falls. Color temperature describes this change in light color in terms of absolute temperature (K: Kelvin). This camera is capable of setting the white balance to enable taking pictures with natural coloring under a variety of lighting conditions.

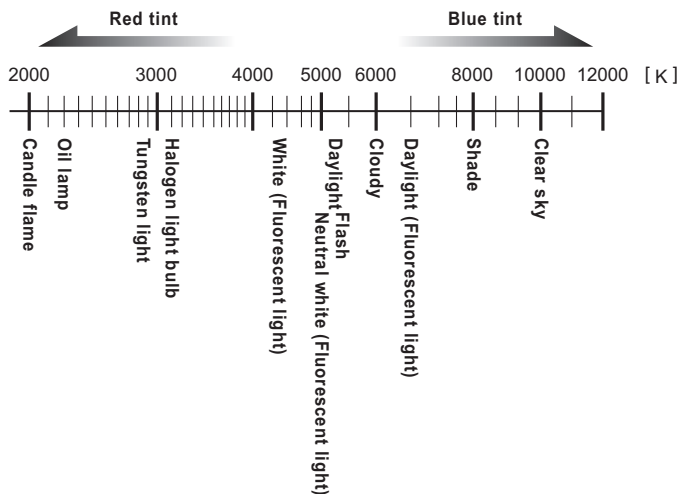

Setting the Color Space

You can set the color space to use. The default setting is [sRGB].

1	sRGB	Sets to sRGB color space.
2	AdobeRGB	Sets to AdobeRGB color space.

Set [Color Space] in the [ Rec. Mode] menu. (p.72)

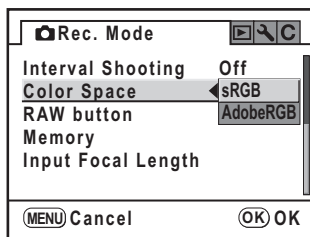

File names differ depending on the color space setting as shown below.
 For sRGB : IMG Pxxxx.JPG
 For AdobeRGB : _IGPxxxx.JPG
 You can change [IMG P] and [IGP] to the desired characters. (p.231)
 [xxxx] indicates the file number. This is displayed as a four-digit sequential number. (p.230)

Color Space

Color ranges for various input/output devices, such as digital cameras, monitors, and printers, differ.

This color range is called the Color Space.

To recreate different color spaces in different devices, standard color spaces have been proposed. This camera supports sRGB and AdobeRGB.

sRGB is mainly used for devices such as a PC.

AdobeRGB covers a wider area than sRGB and is used for occupational uses such as industrial printing.

An image created in AdobeRGB may appear lighter than an image created in sRGB when output from an sRGB compatible device.

Memo



7 Playback Functions

This chapter describes how to use the various playback functions in Playback mode.

How to Operate the Menus During Playback ...	170
Rotating Images	172
Enlarging Playback Images	173
Displaying Multiple Images	175
Displaying a Folder	177
Comparing Images	178
Slideshow	179
Changing Playback Display Method	182
Deleting Multiple Images	185
Protecting Images from Deletion (Protect)	189
Connecting the Camera to AV Equipment	191

How to Operate the Menus During Playback

Press the **MENU** button in Playback mode. The [▶ Playback] menu appears.

[▶ Playback] Menu Setting Items

Perform settings related to playback and editing images in the [▶ Playback] menu.

Item	Function	Page
Playback display	Sets whether to display the Bright/Dark area warning in Playback mode and also sets the initial magnification when enlarging images.	p.184
Instant Review	Sets how long to display Instant Review and whether to display Bright/Dark area warning and histogram.	p.227
Live View	Sets whether to display the grid and AF frame during Live View.	p.114, p.228
Digital Preview	Sets whether to display Bright/Dark area warning and histogram during Digital Preview.	p.115, p.229
Slideshow	Plays back recorded images one after another.	p.181

[C Custom Setting] Menu Setting Items

Set custom functions to fully use the functions of a SLR camera with the Custom Function Menu. The default setting does not change Custom Function. The [C Custom Setting] menu settings are activated when [Setting], the first item, is (On).

Item	Function	Page
Setting	Sets to change Custom Function.	–
32. Saving rotation info	Sets whether to save rotation information when shooting.	–
33. Auto Image Rotation	Sets to automatically rotate images when playing back.	–
Reset Custom Function	Resets all the settings in the Custom Function menu to the defaults.	p.239

Playback Fn Menu Setting Items

Press the **Fn** button during playback. The Fn menu appears.



Press the four-way controller (▲▼◀▶) or the **OK** button to set the operation.

Key or Button	Item	Function	Page
▲	DPOF Settings	Sets the DPOF settings.	p.204
◀	Digital Filter	Changes the color tone of captured images, adds softening and slimming effects, or adjusts the brightness.	p.194
▶	Slideshow	Plays back recorded images one after another.	p.179
▼	RAW Display	Converts RAW images to JPEG format.	p.197
OK	Image Comparison	You can display two images side-by-side.	p.178





- RAW Display (▼) cannot be selected when displaying a JPEG image.
- DPOF Settings (▲) and Digital Filter (◀) cannot be selected when displaying a RAW image.

Rotating Images

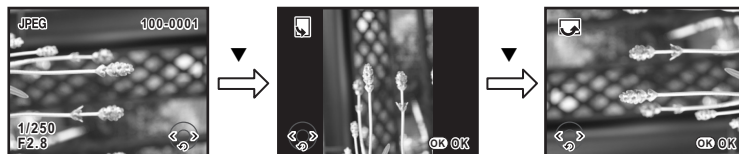
The **K20D** features a function that uses a sensor to rotate and correct the direction of the image when an image is captured with the side of the shutter release button facing up and the Mode dial facing down. You can also rotate the captured image 90° counterclockwise at a time with the steps below.



1 Press the button.

Use the four-way controller ( ) to display the image you want to rotate.

2 Press the four-way controller ().

The image is rotated 90° counterclockwise each time the button is pressed.

3 Press the OK button.

Image rotation information is saved.



You cannot save image rotation information for a protected image or when [33. Auto Image Rotation] in the [C Custom Setting] menu is set to Off.

Enlarging Playback Images

173

Images can be magnified up to 32 times in playback mode.

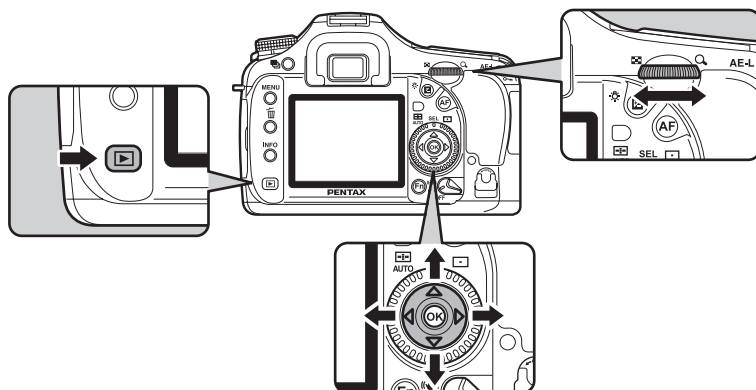

- 1** Press the  button and use the four-way controller ( ) to select an image.

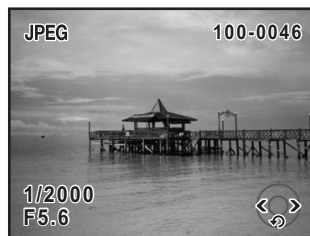

7





Playback Functions

2 Turn the rear e-dial to the right (toward) .

Image enlarges at each calibration (1.2 times* to 32 times).



Operations available during Enlarged view

Four-way controller (   )	Moves area to enlarge
Rear e-dial (toward right)/ Green button	Enlarges image (up to 32 times)
Rear e-dial (toward left)/  button	Reduces image (up to 1.2 times*)
OK button	Returns to the original size
INFO button	Switches information display On/Off
Front e-dial	Retains magnification and magnification area and shows previous/next image
Fn button	Retains magnification and magnification area and shows image comparison (p.178)

* The default setting for the first click (minimum magnification) on the rear e-dial (toward right) is 1.2 times. You can change this in [Playback display] in [ Playback] menu. (p.184)



- You can enlarge the image by following the same procedure during Instant Review (p.57), Live View (p.114) or Digital Preview (p.115). However, the magnifications available for Live View are 4.0 times and 8.0 times.
- The initial full display of vertical images is displayed with a magnification of 0.75 times that of horizontal images, therefore, magnification at the first click starts at 1.0 times.

Displaying Multiple Images

You can display 4, 9 or 16 images on the monitor at the same time.

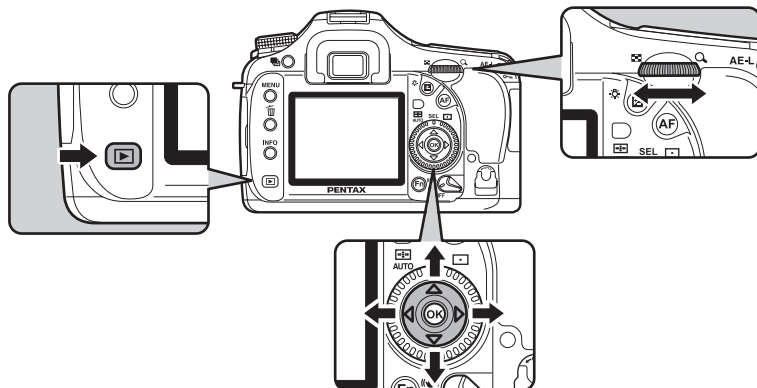



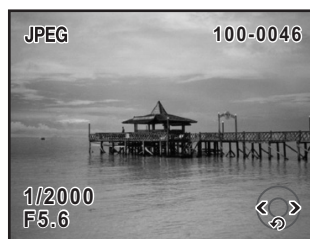

The default setting is 9-image display. The number of images can be changed but 9-image display is explained here.

1 Press the button.



2 Turn the rear e-dial to the left (toward).

The multi-image display screen appears. Up to nine thumbnail images will be displayed at once. Use the four-way controller (   ) to select an image. A scroll bar appears at the right of the screen. With an image selected in the bottom row, pressing the four-way controller () displays the next nine images.

[?] appears for an image that cannot be displayed.

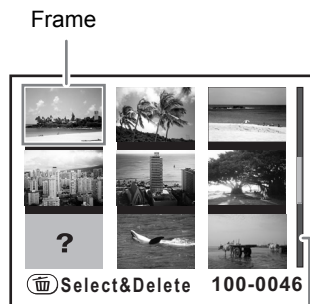

Scroll bar

- 3 Turn the rear e-dial to the right (towards ) or press the OK button.**

A full screen display of the selected image appears.

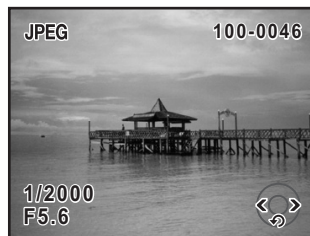





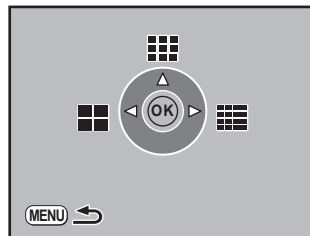

Selecting the Number of Images to Display

- 1 In the multi-image display screen, press the Fn button.**

The multi-image options screen appears.



- 2 Use the four-way controller (  ) to select the number of images to display at once.**

	4 images
	9 images
	16 images

The camera returns to the multi-image display screen.

Displaying a Folder

You can display the contents of folders in the multi-image display screen.

- 1 Turn the rear e-dial to the left in the multi-image display screen.**

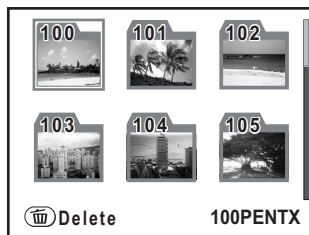

- 2 Use the four-way controller (▲▼◀▶) to select the folder you want to display and press the OK button.**

The images in the folder are displayed according to the number selected in the multi-image options screen.



Press the  button to delete all images in the selected folder. (p.188)

Comparing Images

You can display two images side-by-side.

1 Press the **Fn** button in Playback mode, and then press the **OK** button.

Two images are displayed side-by-side. The same image is displayed on the left and right. Turn the front e-dial to select the images to compare.



You can also press the **Fn** button in Enlarged view to display image comparison.

Operations available during image comparison

OK button	The selection frame changes to both images, left image, and right image each time the button is pressed.
Four-way controller (▲▼◀▶)	Moves area to enlarge. When the selection frame is selecting both images, you can operate both images at the same time.
Green button	Returns the enlarge display position to the center.
Rear e-dial	Enlarges or reduces the image. When the selection frame is selecting both images, you can operate both images at the same time.
Front e-dial	When the selection frame is selecting the left or right image, the previous/next image is displayed.
INFO button	Switches information display On/Off.
🗑️ button	When the selection frame is selecting the left or right image, the selected image is deleted.

2 Press the **Fn** button.

The camera returns to the normal Playback mode.

Slideshow

You can play back all images recorded on your SD Memory Card successively. To start continuous playback, use the menu screen displayed on the monitor.

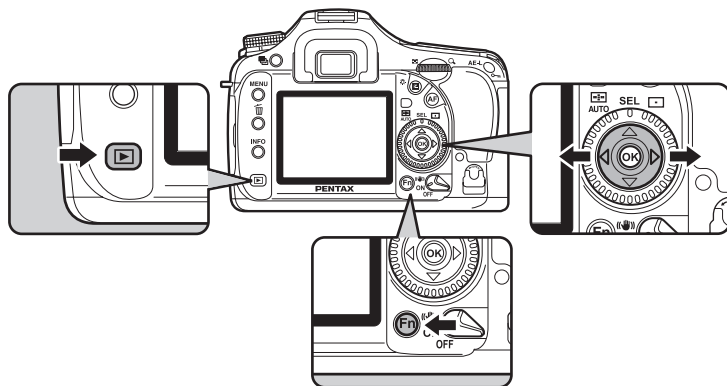

1 Press the  button and use the four-way controller ( ) to select an image to be displayed first.

2 Press the Fn button.

The Fn menu appears.



3 Press the four-way controller (▶).

Start screen is displayed and slideshow begins.

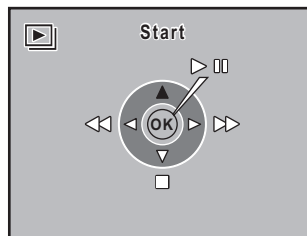

Operations available during a slideshow

OK button	Pause
Four-way controller (◀)	Shows previous image
Four-way controller (▶)	Shows next image
Four-way controller (▼)	Stop

Operations available when paused

OK button	Resumes playback (Restart)
Four-way controller (◀)	Shows previous image
Four-way controller (▶)	Shows next image
Four-way controller (▼)	Stop

4 Stop the slideshow.

Slideshow ends when one of the following is performed during playback or when paused.

- Four-way controller (▼) is pressed *1
- [▶] button is pressed *1
- **MENU** button is pressed *1
- Shutter release button is pressed halfway or fully *2
- **AF** button is pressed *2
- Main switch is turned to the ⌂ position *2
- Mode dial is turned *2

*1 After slideshow ends, the camera switches to normal Playback mode.

*2 After slideshow ends, the camera switches to Capture mode.



Set the display time for slideshow in the [▶ Playback] menu. Alternatively, start the slideshow from the [▶ Playback] menu. (p.181)

Setting the Slideshow Display Interval

Set image display interval for slideshow to [3 sec], [5 sec], [10 sec] or [30 sec]. The default setting is [3 sec].

Set whether or not to play back repeatedly. The default setting is [Off].

- 1 Select [Slideshow] in the [▶ Playback] menu.

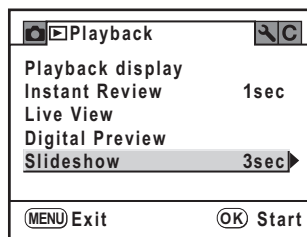

- 2 Press the four-way controller (▶).

- 3 Press the four-way controller (▶) and use the four-way controller (▲▼) to select the image display interval.

Press the **OK** button.

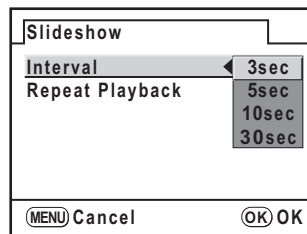

- 4 Use the four-way controller (▼) to select [Repeat Playback].

- 5 Use the four-way controller (◀▶) to select (On) or (Off).

- 6 Press the **MENU** button.

The camera returns to the [▶ Playback] menu.

Press the **OK** button to start slideshow.

Changing Playback Display Method

The camera switches display information when you press the **INFO** button in the Playback screen.

Standard	Captured image and indicators are displayed.
Histogram	Images and histogram (Brightness/RGB) are displayed.
Detailed Info	Shooting information appears with a small image in the upper left.
No info. Display	Only captured images are displayed.



- Refer to p.25 for various display information details.
- The information that is shown first during playback is the same as that of the last playback in the previous session. The [Standard] screen can always be displayed first by setting [Memory] in the [Rec. Mode] menu.

Using the Histogram

A histogram shows the brightness distribution of an image. The horizontal axis represents brightness (dark at the left and bright at the right) and the vertical axis represents the number of pixels.

The **K20D** features two histogram displays. The “Brightness histogram” shows the distribution of brightness and the “RGB histogram” shows the distribution of color intensity.

☞ Histogram Display (p.26)

The shape of the histogram before and after shooting tells you whether the brightness and contrast are correct or not, and lets you decide if you need to use EV compensation and take the picture again.

☞ Adjusting the Exposure (p.100)

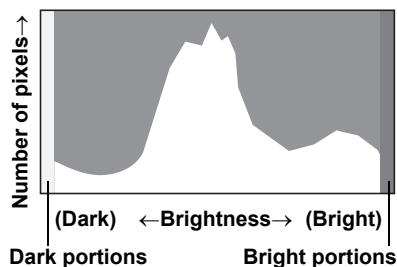

Understanding Brightness

If the brightness is correct, the graph peaks in the middle. If the image is too dark, the peak is on the left side, and if it is too bright, the peak is on the right side.

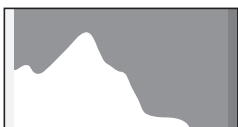

Dark image

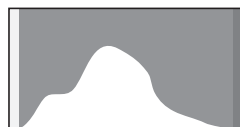

Correct image

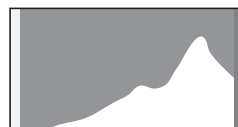

Bright image

When the image is too dark, the part to the left is cut off (dark portions with no detail) and when the image is too bright, the part to the right is cut off (bright portions with no detail).

Bright portions blink red on the monitor and dark portions blink yellow when Bright/Dark area is on.

☞ [Playing Back Images \(p.68\)](#)

☞ [Setting the Display for Instant Review, Live View and Digital Preview \(p.227\)](#)

Understanding Contrast

The graph peaks gradually in the middle for images in which contrast is balanced. The graph peaks on both sides but sinks in the middle for images with a large difference in contrast and low amounts of mid-level brightness.

Understanding Color Balance

Distribution of color intensity is displayed for each color in the RGB histogram. The right side of the graphs look similar for images that have White Balance adjusted well. If only one color is lopsided to the left, that color is too intense.

☞ [Setting the White Balance \(p.160\)](#)

Setting the Playback Display

You can set whether or not to display the Bright/Dark area warning in Playback mode and set the initial magnification when enlarging images.

1 Select [Playback display] in the [▶ Playback] menu.

2 Press the four-way controller (▶).

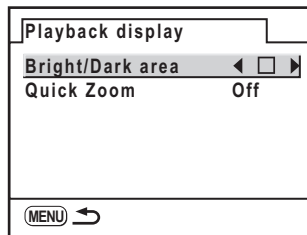

3 Use the four-way controller (◀▶) to select (On) or (Off).

4 Use the four-way controller (▼) to select [Quick Zoom].

5 Press the four-way controller (▶) and use the four-way controller (▲▼) to select the magnification.

6 Press the OK button.

7 Press the MENU button twice.

The camera is ready to take or play back images.

Deleting Multiple Images

Deleting All Images

You can delete all saved images at once.



Deleted images cannot be restored.



A confirmation screen appears when there are protected images.

1 Press the button.

2 Press the button twice.

The Delete All screen appears.

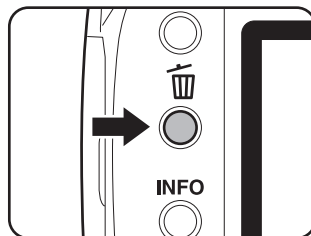

3 Use the four-way controller () to select [Delete All].



4 Press the OK button.

All images are deleted.

A confirmation screen appears when there are protected images. Press the four-way controller (▲▼) to select [Delete All] or [Leave All] and press the OK button.



Deleting Selected Images (from Multi-image Display)

You can delete multiple images from the multi-image display at once.



- Deleted images cannot be restored.
- Protected images cannot be deleted.
- You can select up to 100 images at a time.

7

Playback Functions

1 Press the button.

2 Turn the rear e-dial to the left (toward).

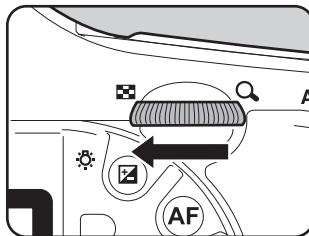

The multi-image display screen appears.



3 Press the button.

appears on the images.

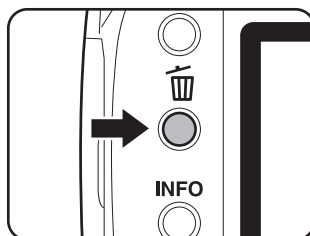

4 Use the four-way controller (▲▼◀▶) to move to the images to delete and press the OK button.

Image is selected and appears.
Protected images cannot be selected.

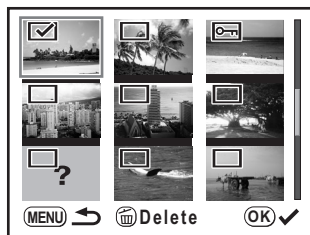

5 Press the button.

The Delete confirmation screen appears.

6 Use the four-way controller (▲▼) to select [Select&Delete].



7 Press the OK button.





The selected images are deleted.

Deleting a Folder

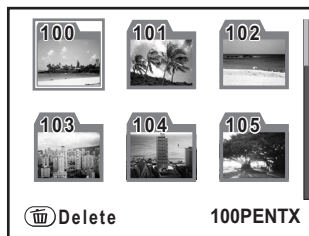
You can delete all images in a selected folder.

- 1 Turn the rear e-dial to the left (toward ) in Playback mode to display the folders.





- 2 Press the four-way controller (, , , ) to select the folder to delete and press the  button.

The Delete Folder confirmation screen appears.



- 3 Use the four-way controller () to select [Delete].

The folder and all images in the folder are deleted.

A confirmation screen appears when there are protected images. Press the four-way controller (, ) to select [Delete All] or [Leave All] and press the **OK** button.

Protecting Images from Deletion (Protect)

You can protect images from being accidentally deleted.



Even protected images are deleted if the SD Memory Card is formatted.

1 Press the button and use the four-way controller (◀▶) to select an image.

2 Press the button.

The Protect screen appears.

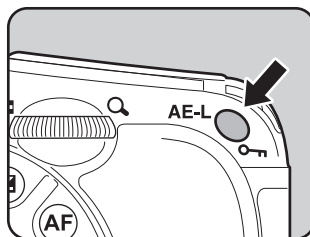

3 Use the four-way controller (▲▼) to select [Protect].



4 Press the OK button.

The selected image is protected.





- Select [Unprotect] in Step 3 to cancel the Protect setting.
- The icon is displayed when playing back protected images. (p.25, p.26)

Protecting All Images

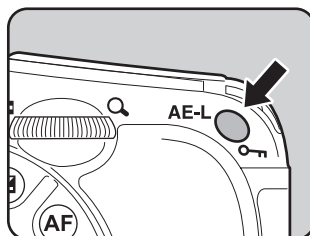
- 1** Press the  button.
- 2** Press the  button twice.
The Protect all images screen appears.



- 3** Press the four-way controller ( ) to select [Protect] and press the OK button.

All images saved in the SD Memory Card are protected.



Select [Unprotect] in Step 3 to cancel the Protect setting on all of the images.

Connecting the Camera to AV Equipment

By using the provided video cable (I-VC28), you can play back images using a TV or other device with a video IN jack as your monitor. Make sure that both the TV and the camera are turned off before connecting the cable.

☞ [Selecting the Video Output Format \(p.233\)](#)

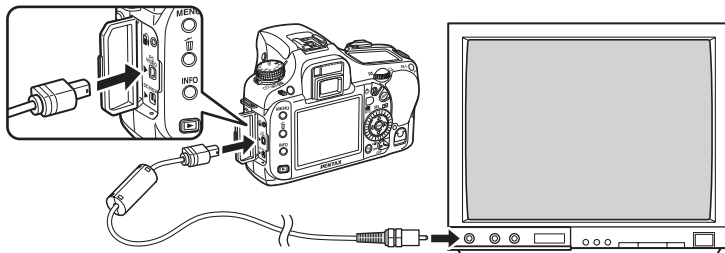

- 1** Open the terminal cover, face the arrow on the provided video cable toward the ▲ mark on the camera, and connect the video cable to the USB/Video terminal.
- 2** Connect the other end of the video cable to the video IN jack on the AV device.
- 3** Turn the AV device and camera on.



- If you intend to use the camera continuously for a long period, use of the AC adapter D-AC50 (optional) is recommended. (p.39)
- For AV equipment with multiple video IN jacks (such as TVs), check the operating manual of the AV device, and select the video IN jack to which the camera is connected.
- Depending on the country or region, images may fail to be played back if the video output format is set different from the one in use there. If this happens, change the video output format setting. (p.233)
- The camera monitor turns off while the camera is connected to the AV device.

Memo



8 Processing Images

This chapter describes how to process pictures taken and edit RAW images.

Processing Images with Digital Filters	194
Editing RAW Images	197

Processing Images with Digital Filters

You can edit shot images using digital filters. Processed images are saved under a different name.



TIFF and RAW images cannot be processed using the digital filter.

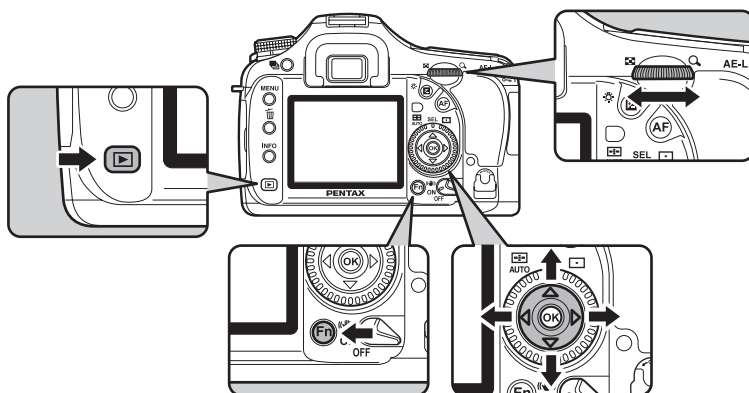

8

Processing Images

1 Press the Fn button in Playback mode.

The Fn menu appears.



2 Press the four-way controller (◀).

The screen for selecting the filter appears.

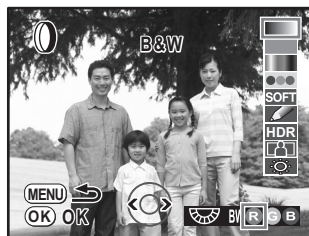

3 Use the four-way controller (◀▶) to select an image.

4 Use the four-way controller (▲▼) to select a filter.

Select a filter and preview the effects on the image.

5 Adjust with the front e-dial and rear e-dial.

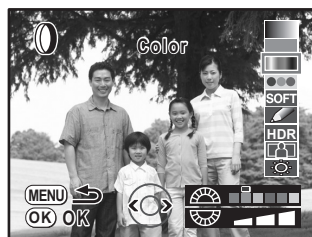

Color Filter

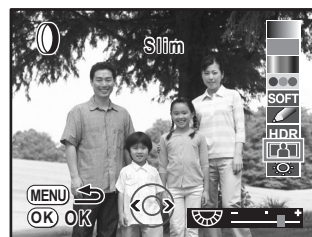

Slim Filter

Filter name	Function	Front e-dial	Rear e-dial
B&W	Converts to a black and white image. Changes the contrast to appear as if a B&W color filter was used.	—	BW/R/G/B
Sepia	Adds a vintage touch to photos by converting them to sepia color. Select from three levels of density.	—	Density (3 levels)
Color	Adds a color filter to the image. Select from 18 filters (6 colors × 3 tones).	Red/Green/ Blue/Yellow/ Magenta/ Cyan	Density of each color (3 levels)
Extract Color	Leaves the selected color in the image and converts the rest of the image to the same color. Select from six extracted colors.	—	R/G/B/ Y/M/C
Soft	Creates a soft image by lightly fading the entire image. Select from three levels.	—	Soft level (3 levels)
Illustration	Creates an image that looks as though it was drawn with a pencil. The setting cannot be adjusted.	—	—

Filter name	Function	Front e-dial	Rear e-dial
HDR	Creates an image that looks as though it is a high dynamic range image. Select from three levels.	—	HDR level (3 levels)
Slim	Changes the horizontal and vertical ratio of images. Adjust height or width up to two times the original size.	—	Left: Wide Right: Slim
Brightness	Changes the brightness of images. Adjust in a range of ± 8 levels.	—	Left: Dark Right: Light

When another image is selected with the four-way controller (◀▶), the image appears in the set filter.

6 Press the OK button.

The save confirmation screen appears.

7 Use the four-way controller (▲▼) to select [Save as].

Press the **MENU** button to return to the previous screen. Select [Cancel] and press the **OK** button to return to single-image playback mode.



8 Press the OK button.

The filtered image is saved under a different name.

Editing RAW Images

You can convert captured RAW files into JPEG or TIFF files.

Editing One RAW Image

- 1 Press the **Fn** button in Playback mode.

The Fn menu appears.



- 2 Press the four-way controller (**▼**).

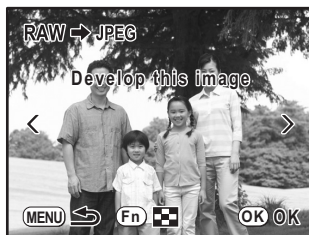

- 3 Press the **OK** button.

The parameters recorded in the image file appear.

To specify the parameters, see “Specifying the Parameters” (p.200).

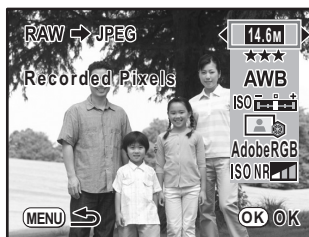

4 Press the OK button.

The save confirmation screen appears.

**5 Use the four-way controller (▲▼) to select [Save as].**

Press the **MENU** button to return to the previous screen. Select [Cancel] and press the **OK** button to return to single-image playback mode.

6 Press the OK button.

The edited image is saved under a different name.

Editing All RAW Images

Selects and edits multiple RAW images.

1 Press the Fn button in Playback mode.

The Fn menu appears.

2 Press the four-way controller (▼).**3 Press the Fn button.**

The multi-image display screen appears.

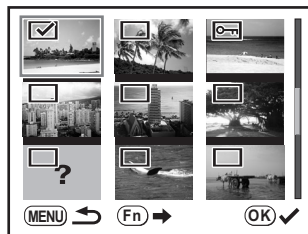

4 Press the four-way controller (▲▼◀▶) to select the RAW image to edit and press the OK button to select the check box (☑).

Press the **OK** button again to clear the check box (☐).

Turn the rear e-dial toward  to select single-image display and view the image.

You can select up to 100 images at a time.

5 Press the Fn button and use the four-way controller (▲▼) to select [Open].

To specify the parameters, select [Change Setting]. See “Specifying the Parameters” (p.200).

6 Press the OK button.

The save confirmation screen appears.

7 Use the four-way controller (▲▼) to select [Save as JPEG] or [Save as TIFF].

Press the **MENU** button to return to the previous screen. Select [Cancel] and press the **OK** button to return to single-image playback mode.

8 Press the OK button.

All selected RAW images are edited and saved in a new folder.

Specifying the Parameters

Specifies the parameters for editing RAW images. When multiple images are selected, all images are edited with the same parameters.

If Quality Level is not set to [TIFF], images are saved as JPEG images.

- 1** Select [Change Setting] in Step 3 of p.197 or Step 5 of p.199 and press the OK button.

The parameter setting screen appears.



- 2** Use the four-way controller (▲ ▼) to choose the parameter you want to change.

The following parameters can be changed.

JPEG Recorded Pixels ^{*1}	14.6M (4672×3104)/10M (3872×2592)/ 6M (3008×2000)/2M (1824×1216)
Quality Level	★★★★ (Premium)/★★★ (Best)/ ★★ (Better)/★ (Good)/TIFF
White Balance ^{*2}	AWB (Auto), ☀ (Daylight), ☷ (Shade), ☁ (Cloudy), ☀N (Daylight white fluorescent lights), ☀W (White light fluorescent lights), ☀D (Daylight colors fluorescent lights), ☀ (Tungsten Light), ⚡ (Flash), ⚙ (Manual), Color Temperature (three types)
Sensitivity	-2.0~+2.0
Custom Image	Image Tone/Saturation (Filter Effect)/Hue (Toning)/ Contrast/Sharpness
Color Space	sRGB/AdobeRGB
High-ISO Noise Reduction	Noise reduction level (4 levels)

*1 If Quality Level is set to [TIFF], this is fixed at 14.6M.

*2 White Balance cannot be set for RAW files taken in Multi-exposure mode.

3 Use the four-way controller (◀▶) to change the parameter.

Use the four-way controller (▶) to display the setting screen for White Balance/Custom Image. To make these settings, see “Adjusting the White Balance” (p.160) and “Setting the Image Processing Method in Capture Mode (Custom Image)” (p.154).



- You cannot save the background image or use Digital Preview with White Balance/Custom Image.
- Manual white balance measures an arbitrary position on the image using only spot metering. Pressing the shutter release button fully cancels RAW image editing and changes to Capture mode.

4 Press the OK button.

The save confirmation screen appears.

5 Select [Save as] and press the OK button.

The RAW image is edited and saved as a new image.

Memo

9 Printing from the Camera

This chapter describes how to make the printing settings.

Setting the Printing Service (DPOF)	204
Printing Using PictBridge	207

Setting the Printing Service (DPOF)

You can order conventional photograph prints by taking the SD Memory Card with recorded images to a store for a printing service.

DPOF (Digital Print Order Format) settings allow you to specify the number of copies or to imprint the date.



- DPOF settings cannot be applied to RAW images.
- You can make DPOF settings for up to 999 images.

Printing Single Images

Set the following items for each image.

Copies	Selects the number of copies. You can print up to 99 copies.
Date	Specifies whether you want the date inserted on the print or not.

1 Press the button and use the four-way controller () to select an image.

2 Press the Fn button.

The Fn menu appears.



3 Press the four-way controller ().

The DPOF screen appears.

If DPOF settings have already been made for an image, the previous number of prints and date setting ((On) or (Off)) will be displayed.



4 Use the four-way controller (◀▶) to choose the number of copies and press the four-way controller (▼).

The frame moves to [Date].

5 Use the four-way controller (◀▶) to choose whether to insert the date (☑) or not (☐).

- ☑ : The date will be printed.
- ☐ : The date will not be printed.

You can select the next or previous image by turning the front e-dial. Repeat Steps 4 and 5 to set multiple images (up to 999).



6 Press the OK button.

The edited DPOF settings for all images are saved and the camera returns to single-image playback mode.



Depending on the printer or printing equipment at the photo processing lab, the date may not be imprinted on the pictures even if the DPOF setting was made.



- To cancel DPOF settings, set the number of copies to [00] in Step 4 and press the **OK** button.
- Press the **MENU** button while setting to cancel editing of all images.

Settings for All Images

1 Press the Fn button in Playback mode.

The Fn menu appears.



2 Press the four-way controller (▲).

The DPOF screen appears.



3 Press the Fn button.

The screen for making DPOF settings for all images appears.

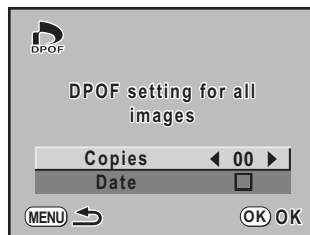

4 Use the four-way controller (◀▶) to choose the number of copies and whether to insert the date (☑) or not (☐).

Refer to Steps 4 and 5 of "Printing Single Images" (p.205) for details of how to make the settings.

5 Press the OK button.

The DPOF settings for all images are saved and the camera returns to single-image playback mode.

9

Printing from the Camera



The number of copies specified in settings for all images applies to all the images. Before printing, check that the number is correct.



Settings for single images are canceled when settings are made for all images.

Printing Using PictBridge

This function lets you print images directly from the camera without using a PC (direct printing).

Connect the camera and PictBridge compatible printer with the included USB cable (I-USB17) to print directly.

Select the images you want to print, the number of copies and whether to insert the date or not on the camera after connecting to the printer.

Direct printing is performed in the following steps.

Set [USB Connection] on camera to [PictBridge] (p.208)



Connect the camera to the printer (p.209)



Set the printing options

Print single images (p.210)

Print all images (p.212)

Print with DPOF settings (p.213)



- Use of the AC adapter D-AC50 (optional) is recommended when connecting the camera to a printer. The printer may not work properly or the image data may be lost if the battery runs out of power while the camera is connected to the printer.
- Do not disconnect the USB cable during data transfer.
- Depending on the type of printer, not all the settings made on the camera (such as print settings and DPOF settings) may be valid.
- A printing error may occur if the selected number of copies exceeds 500.
- Printing an index of images, where multiple images appear on a single sheet, may not be possible unless the printer supports index printing. For index prints, you may need to use a PC.
- RAW images cannot be printed directly from the camera. Use [RAW display] (p.197) to convert to a JPEG image or transfer to a PC and use PENTAX PHOTO Browser 3 to print RAW images.
- See the "PENTAX PHOTO Browser 3/PENTAX PHOTO Laboratory 3 Operating Manual" when connecting to a PC.

Setting Transfer Mode

1 Press the **MENU** button.

2 Use the four-way controller (◀▶) to select the [↖ Set-up] menu.

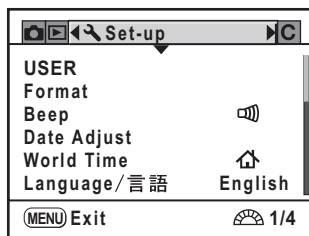

3 Use the four-way controller (▲▼) to select [USB Connection].

4 Press the four-way controller (▶).

A pop-up menu appears.

5 Use the four-way controller (▲▼) to select [PictBridge].

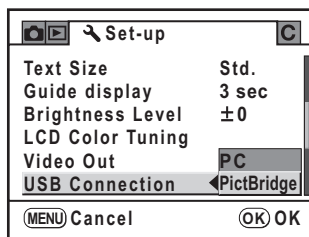

6 Press the **OK** button.

The setting is changed.

7 Press the **MENU** button.

Connecting the Camera to the Printer

- 1** Turn off the camera.
- 2** Face the arrow on the provided USB cable toward the ▲ mark on the camera, and connect the camera and PictBridge compatible printer.

The PictBridge logo is displayed on PictBridge compatible printers.

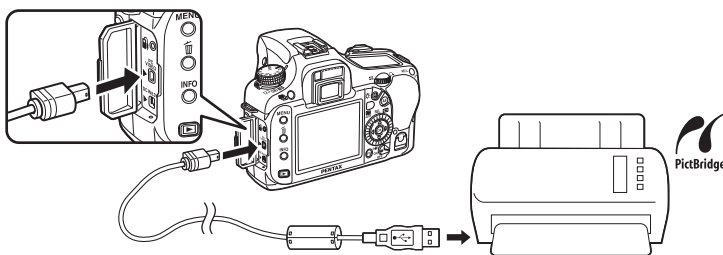

- 3** Turn the printer on.
- 4** After printer start-up is complete, turn the camera on.

The PictBridge menu appears.

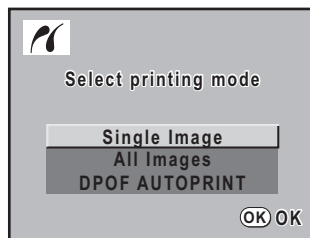

PictBridge menu is not displayed if [USB Connection] is set to [PC].

Printing Single Images

- 1 Use the four-way controller (**▲▼**) to select [Single Image] on the PictBridge menu.

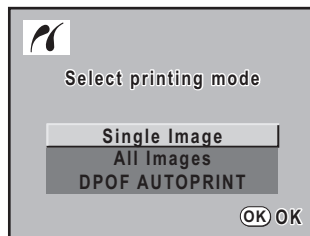

- 2 Press the OK button.

The Print single image screen appears.

- 3 Use the four-way controller (**◀▶**) to choose an image to print.

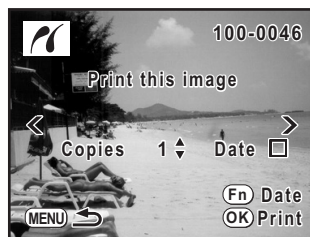

- 4 Use the four-way controller (**▲▼**) to choose the number of copies.

You can print up to 99 copies.

- 5 Use the Fn button to choose whether to insert the date () or not ()

- : The date will be printed.
- : The date will not be printed.

- 6 Press the OK button.

The print settings confirmation screen appears.

Proceed to Step 12 to print the images using the default setting.

To change the print settings, go to Step 7.

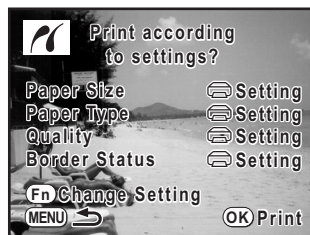

7 Press the Fn button.

The screen for changing print settings appears.

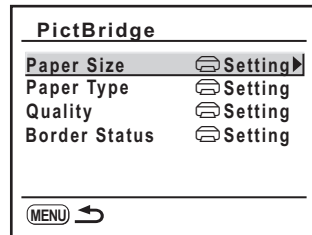

8 Select [Paper Size] and press the four-way controller (▶).

The Paper Size screen appears.

9 Use the four-way controller (▲▼◀▶) to choose the paper size.

You can only choose a size that is supported by your printer.

When [⊞ Setting] is selected, images are printed according to the printer settings.

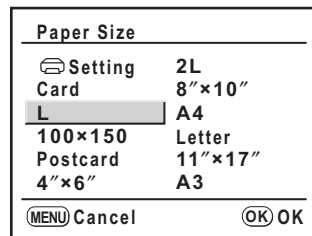

10 Press the OK button.

11 Repeat Steps 8 to 10 to set [Paper Type], [Quality] and [Border Status].

The print settings change screen appears after each item has been set. When [⊞ Setting] is selected for these print settings, images are printed according to the printer settings.

[Paper Type] with more ★s supports higher quality paper.

[Quality] with more ★s indicates higher print quality.

12 Press the MENU button.

The camera returns to the print settings confirmation screen in Step 6.

13 Press the OK button.

The image is printed according to the settings.

Press the **MENU** button to cancel printing.

Printing All Images

- 1 Use the four-way controller (▲▼) to select [All Images] on the PictBridge menu.

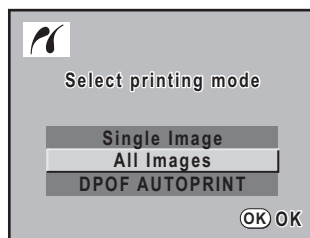

- 2 Press the OK button.

The Print all images screen appears.

- 3 Choose the number of copies and whether to imprint the date or not.

The number of copies and the date setting that you choose apply to all of the images. Refer to Steps 4 and 5 of “Printing Single Images” (p.210) for details on how to make the settings.

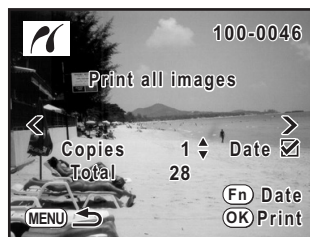

- 4 Press the OK button.

The print settings confirmation screen appears.

Refer to Steps 7 to 11 of “Printing Single Images” (p.211) for details on how to change the settings.

- 5 Press the OK button on the print settings confirmation screen.

All the images are printed according to the settings. Press the **MENU** button to cancel printing.

Printing Images Using the DPOF Settings

1 Use the four-way controller (▲▼) to select [DPOF AUTOPRINT] on the PictBridge menu.

2 Press the OK button.

The Print w/DPOF settings screen appears.

Use the four-way controller (◀▶) to check the number of copies for each image, whether the date is imprinted or not, and total number of copies. The number of copies and the date setting are set with the Print Service. (p.204)

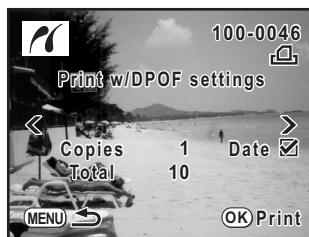

3 Press the OK button.

The print settings confirmation screen appears.

Refer to Steps 7 to 11 of “Printing Single Images” (p.211) for details on how to change the settings.

4 Press the OK button on the print settings confirmation screen.

The images are printed according to the settings.

Press the **MENU** button to cancel printing.

Disconnecting the USB Cable

Disconnect the USB cable from the camera and printer when you have finished printing.

1 Turn off the camera.

2 Disconnect the USB cable from the camera and printer.

Memo





10 Camera Settings

This chapter describes how to change the camera settings.

How to Operate the [Setup] Menu	216
Formatting the SD Memory Card	218
Setting the Beep Setting, Date and Time, and Display Language	219
Adjusting the Monitor and the Menu Display	225
Setting the Image File Naming Convention	230
Selecting the Video Output Format and Power Settings	233
Using Pixel Mapping	235
Selecting Capture Mode Settings to Save in the Camera	236

How to Operate the [Set-up] Menu

Press the **MENU** button and use the four-way controller ( ) to display the [ Set-up] menu.

[Set-up] Menu Setting Items

Perform various settings related to the camera in the [ Set-up] menu.

Item	Function	Page
USER	Registers the current camera settings to USER.	p.133
Format	Formats the SD Memory Card.	p.218
Beep	Switches the beep tone on/off.	p.219
Date Adjust	Sets the date format and time.	p.220
World Time	Sets display of local date and time of a specified city in addition to the present location on the monitor when traveling overseas.	p.221
Language/言語	Changes the language in which menus and messages appear.	p.224
Text Size	Sets the size of the text selected in the menus.	p.225
Guide display	Sets to display indicators in the monitor.	p.225
Brightness Level	Changes the brightness of the monitor.	p.226
LCD Color Tuning	Adjusts the color of the monitor.	p.226
Video Out	Sets the output format to the TV monitor.	p.233
USB Connection*1	Sets the USB cable connection (PC or printer).	p.208
Auto Power Off	Sets the time to turn off automatically.	p.233
Folder Name	Sets the method used to assign folder names for storing images.	p.230
File Name	Sets the file name of the image to be saved.	p.231
Select battery	Sets battery priority for when battery grip is attached.	p.234
Pixel Mapping	Maps out and corrects for any defective pixels in the CMOS sensor.	p.235
Dust Alert	Detects dust adhering to the CMOS sensor.	p.252
Dust Removal	Cleans the CMOS sensor by shaking it.	p.252

Item	Function	Page
Sensor Cleaning	Locks the mirror in the up position for cleaning the CMOS sensor.	p.254
Reset	Resets all settings.	p.238
Reset USER setting ^{*2}	Resets the saved USER mode settings.	p.240

*1 Refer to p.11 of the "PENTAX PHOTO Browser 3/PENTAX PHOTO Laboratory 3 Operating Manual" for details on connecting the camera to a PC.

*2 In USER mode, this is displayed instead of Reset.

Formatting the SD Memory Card

Use this camera to format (initialize) an SD Memory Card that is unused or has been used on other cameras or digital devices.

Formatting will delete all the data on the SD Memory Card.



- Do not open the card cover while formatting SD Memory Card. The card may be damaged beyond use.
- Formatting will delete all data, either protected or unprotected. Be aware.

1 Select [Format] in the [↶ Set-up] menu.

2 Use the four-way controller (▶) to display the Format screen.

3 Use the four-way controller (▲▼) to select [Format].

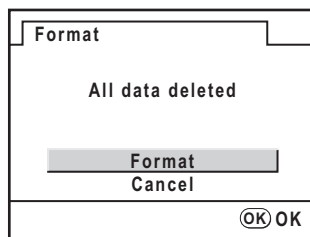

4 Press the OK button.

Formatting starts. When formatting is completed, the monitor turns off and the camera is ready to take pictures.

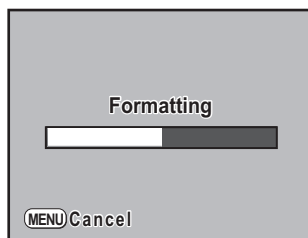

Setting the Beep Setting, Date and Time, and Display Language

Turning the Beep On and Off

You can turn the camera operation beep on or off. The default setting is all (On).

There are five items that you can set: In-focus, AE Lock, **RAW** button, Self-timer and Remote Control.

- 1 Select **[Beep]** in the **[Set-up]** menu.

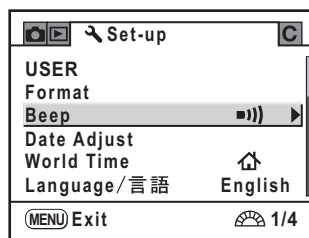

- 2 Press the four-way controller (▶).

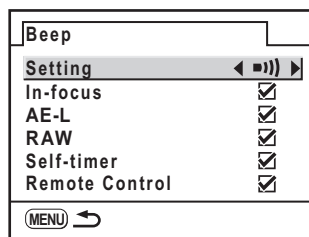

- 3 Select an item and use the four-way controller (◀▶) to select **On** or **Off**.



You can turn all the beeps off by selecting **[Setting]** and pressing the four-way controller (◀▶).

Changing the Date and Time and the Display Style

You can change the initial date and time settings. You can also set the display style. Choose [mm/dd/yy], [dd/mm/yy] or [yy/mm/dd]. Choose [12h] (12 hour) or [24h] (24 hour) for time display method.

Set in [Date Adjust] in the [ Set-up] menu. (p.216)

 Setting the Date and Time (p.48)

Date Adjust	
Date Style	mm/dd/yy/24h
Date	01 / 01 / 2008
Time	00 : 00
 Cancel	 OK

Setting the World Time

The date and time selected in “Initial Settings” (p.45) serve as the date and time of your present location.

Setting [World Time] enables you to display the local date and time on the monitor when traveling overseas.

1 Select [World Time] in the [**↖** Set-up] menu.

2 Press the four-way controller (**▶**).

The World Time screen appears.

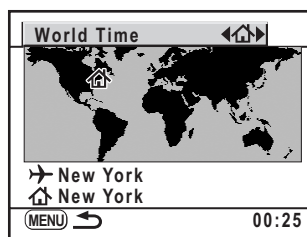

3 Use the four-way controller (**◀▶**) to select **→** (Destination) or **↖** (Hometown).

This setting changes the date and time on the guide display screen.

4 Press the four-way controller (**▼**).

The selection frame moves to **→** (Destination setting).

5 Press the four-way controller (**▶**).

The screen for magnifying the Destination region appears.

Turn the rear e-dial to change the region to magnify.

6 Use the four-way controller (**◀▶**) to select the Destination city.

The current time, location and time difference of the selected city appears.

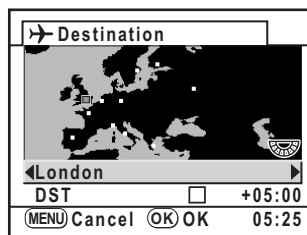

7 Use the four-way controller (▼) to select [DST].

8 Use the four-way controller (◀▶) to select (On) or (Off).

Select (On) if the Destination city uses daylight saving time (DST).

9 Press the OK button.

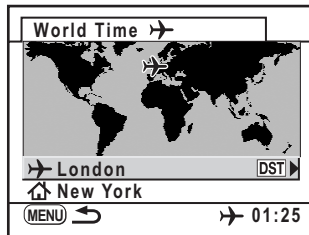

The World Time setting is saved.



10 Press the MENU button twice.

The camera is ready to take a picture.



- See "List of World Time Cities" (p.223) for cities that can be specified as a destination.
- Select  (Hometown setting) in Step 4 to set the city and DST setting.
-  appears on the guide display screen if World Time is set to  (Destination). (p.22)
- When you change World Time, the Video Out (p.233) setting changes to the default setting for that city.

List of World Time Cities

Region	City	Region	City
North America	Honolulu	Africa/ West Asia	Dakar
	Anchorage		Algiers
	Vancouver		Johannesburg
	San Francisco		Istanbul
	Los Angeles		Cairo
	Calgary		Jerusalem
	Denver		Nairobi
	Chicago		Jeddah
	Miami		Tehran
	Toronto		Dubai
	New York	Karachi	
Halifax	Kabul		
Central and South America	Mexico City	Male	
	Lima	Delhi	
	Santiago	Colombo	
	Caracas	Kathmandu	
	Buenos Aires	Dacca	
	Sao Paulo	East Asia	Yangon
	Rio de Janeiro		Bangkok
Europe	Lisbon		Kuala Lumpur
	Madrid		Vientiane
	London		Singapore
	Paris		Phnom Penh
	Amsterdam		Ho chi Minh
	Milan		Jakarta
	Rome		Hong Kong
	Copenhagen		Beijing
	Berlin	Shanghai	
	Prague	Manila	
	Stockholm	Taipei	
	Budapest	Seoul	
	Warsaw	Tokyo	
	Athens	Guam	
Helsinki			
Moscow			

Region	City
Oceania	Perth
	Adelaide
	Sydney
	Noumea
	Wellington
	Auckland
	Pago Pago

Setting the Display Language

You can change the language in which the menus, error messages, etc. are displayed.

Set in [Language/言語] in the [ Set-up] menu. (p.216)

You can choose from 18 languages: English, French, German, Spanish, Portuguese, Italian, Dutch, Danish, Swedish, Finnish, Polish, Czech, Hungarian, Turkish, Russian, Korean, Chinese (Traditional/Simplified) and Japanese.

 Setting the Display Language (p.45)

Language/言語		
English	Dansk	Русский
Français	Svenska	한국어
Deutsch	Suomi	中文繁體
Español	Polski	中文简体
Português	Čeština	日本語
Italiano	Magyar	
Nederlands	Türkçe	
(MENU) Cancel		(OK) OK

Adjusting the Monitor and the Menu Display

Setting the Text Size

You can set the size of the text selected in the menus to [Std.] (normal display) or [Large] (magnified display).

Set in [Text Size] in the [Set-up] menu. (p.216)

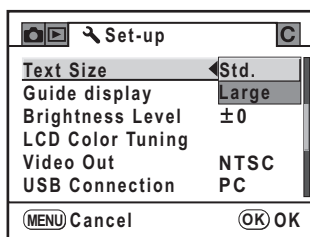

Setting the Guide Display Time

Set the length of time that the guides are displayed on the monitor when the camera is turned on or the exposure mode is changed. (p.22)

Select from [Off], [3 sec], [10 sec] and [30 sec]. The default setting is [3 sec].

Set in [Guide display] in the [Set-up] menu. (p.216)

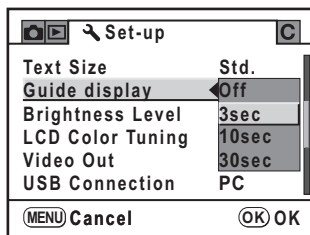

Adjusting the Brightness of the Monitor

You can adjust the brightness of the monitor. Adjust settings when the monitor is hard to see.

Set in [Brightness Level] in the [Set-up] menu. (p.216)

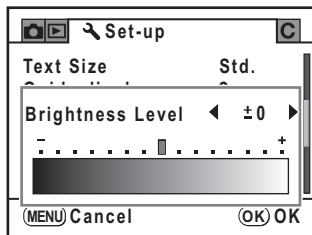

Adjusting the Color of the Monitor (LCD Color Tuning)

Adjusts the color of the monitor.

- 1 Select [LCD Color Tuning] in the [Set-up] menu.
- 2 Press the four-way controller ().

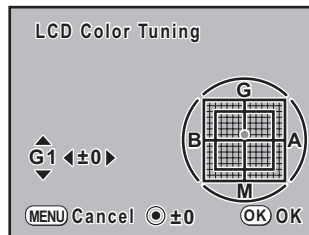

- 3 Use the four-way controller () to adjust toward G or M and use the four-way controller () to adjust toward B or A.

You can adjust the setting to one of 15 levels in each direction.

Press the Green button to reset the adjustment value.

- 4 Press the OK button.

5 Press the MENU button.

The camera returns to the Capture or Playback mode.



Adjust the value toward G or M to adjust the level of the green or magenta color tone. Adjust the value toward B or A to adjust the level of the blue or amber color tone.

Setting the Display for Instant Review, Live View and Digital Preview

You can perform the settings related to Instant Review and Digital Preview.

Setting the Instant Review

You can set the Instant Review display time and whether or not to display the histogram and Bright/Dark area warning. The default settings are [1 sec] for the display time and [Off] for the histogram and Bright/Dark area warning.

1 Select [Instant Review] in the [▶ Playback] menu.

2 Press the four-way controller (▶).

The screen for setting the Instant Review appears.

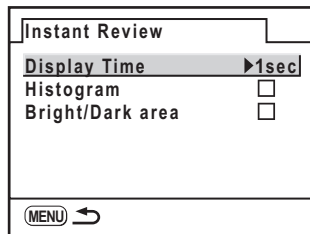

3 Press the four-way controller (▶) and use the four-way controller (▲▼) to select from [1 sec], [3 sec], [5 sec] or [Off].

Press the OK button.

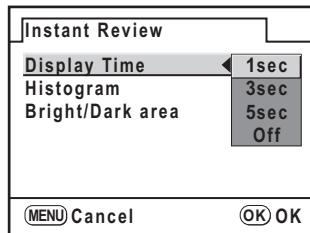

- 4** Use the four-way controller (▼) to select [Histogram].
- 5** Use the four-way controller (◀▶) to select (On) or (Off) for [Histogram].
- 6** Use the four-way controller (▼) to select [Bright/Dark area].
- 7** Use the four-way controller (◀▶) to select (On) or (Off).
- 8** Press the **MENU** button twice.

The camera is ready to take a picture.

Setting the Live View

You can set whether or not to display the grid and AF frame during Live View. Neither is displayed by default.

- 1** Select [Live View] in the [▶ Playback] menu.
- 2** Press the four-way controller (▶).
The screen for setting the Live View appears.

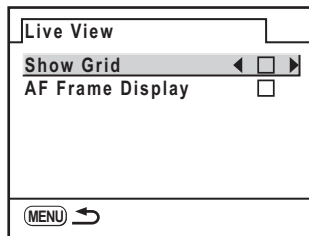

- 3** Use the four-way controller (▲▼) to select an item and use the four-way controller (◀▶) to select (On) or (Off).

- 4** Press the **MENU** button twice.

The camera returns to the Capture or Playback mode.

Setting the Digital Preview

You can set whether or not to display the histogram and Bright/Dark area warning during Digital Preview. The default setting is [Off] for the histogram and Bright/Dark area warning.

1 Select [Digital Preview] in the [▶ Playback] menu.

2 Press the four-way controller (▶).

The screen for setting the Digital Preview appears.

Proceed as from Step 4 in Instant Review.

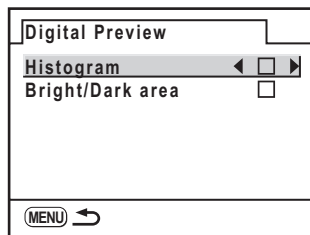

Setting the Image File Naming Convention

Selecting the Folder Name

You can select the method for assigning the folder names for storing images. The default setting is [Date].

Date	The two digits of the [month] and [day] on which the picture was taken are assigned as the folder name in the form of [xxx_MMDD]. [xxx] is a sequential number from 100 to 999. (Example) 101_0125: for folders with pictures taken on January 25th
PENTX	The folder name is assigned in the form of [xxxPENTX]. (Example) 101PENTX

Set in [Folder Name] in the [Set-up] menu. (p.216)

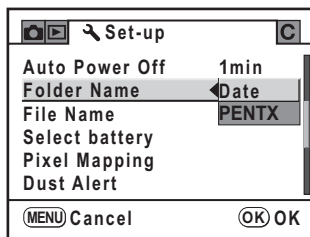

Selecting the File Number Setting

You can select the method for assigning the file number of an image when saved to a new folder. Select (On) or (Off) for [File No.] in [Memory] in the [Rec. Mode] menu. (p.236)

<input checked="" type="checkbox"/> (On)	The file number of the last image saved to the previous folder is saved and subsequent images are assigned sequential file numbers even if a new folder is created.
<input type="checkbox"/> (Off)	The file number of the first image saved to a folder returns to 0001 each time a new folder is created for saving images.



When the number of storable images exceeds 500, captured images are divided into folders of 500 images each. However, in Auto Bracket, images will be stored in the same folder until shooting is completed, even if the number of images exceeds 500.

Setting the File Name

You can change the file names of images.

The default naming conventions for the color space (p.167) settings are as follows.

[xxxx] indicates the file number. This is displayed as a four-digit sequential number. (p.230)

sRGB	IMGPxxxx.JPG
AdobeRGB	_IGPxxxx.JPG

For sRGB, you can change [IMGP] (4 characters) to the desired characters. For AdobeRGB, of the 4 characters you selected, the first 3 are automatically assigned in place of [IGP].

(Example) When set to [ABCDxxxx.JPG] → files are named [_ABCxxxx.JPG] for AdobeRGB

1 Select [File Name] in the [↖ Set-up] menu.

2 Press the four-way controller (▶).

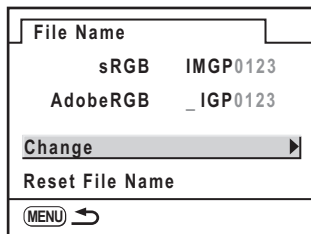

3 Press the four-way controller (▲▼) to select [Change] and press the four-way controller (▶).

The text palette screen appears.

Text selection cursor

Text change cursor

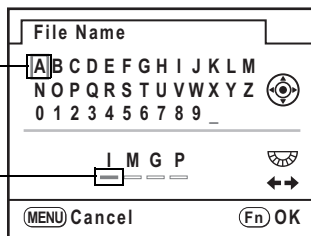

You can use the rear e-dial to move the text change cursor and use the four-way controller (▲▼◀▶) to move the text selection cursor over the text palette. Press the **OK** button to enter the character selected with the text selection cursor to the position of the text change cursor.

4 After entering the desired characters, press the Fn button.

The text is changed.

5 Press the MENU button twice.

The camera returns to the Capture or Playback mode.



You can reset the file name to the default setting by selecting [Reset File Name]. (p.241)

Selecting the Video Output Format and Power Settings

Selecting the Video Output Format

When you connect the camera to AV equipment such as a TV, choose the appropriate video output format (NTSC or PAL) for playing back images.

Set in [Video Out] in the [Set-up] menu. (p.216)

Connecting the Camera to AV Equipment (p.191)

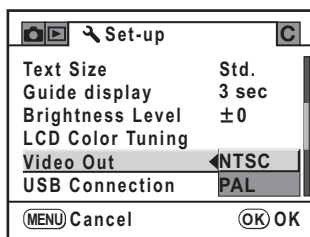

The default video output format differs depending on the region. When you change the region set in World Time, the Video Out setting changes to the default setting for that city.

Setting Auto Power Off

You can set the camera to turn off automatically if unused after a certain length of time. Select from [1 min], [3 min], [5 min], [10 min], [30 min] or [Off]. The default setting is [1 min].

Set in [Auto Power Off] in the [Set-up] menu. (p.216)

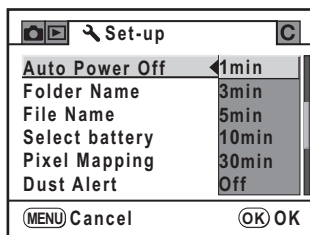

Auto Power Off will not work during slideshow playback, USB connection, or while using the AC adapter.

Selecting a Battery

You can set the battery priority to the camera or the battery grip when a battery grip (p.256) is attached. The default setting is [Auto Select].

1 Select [Select battery] in the [**Set-up**] menu.

2 Press the four-way controller (▶).

The screen for selecting the battery appears.

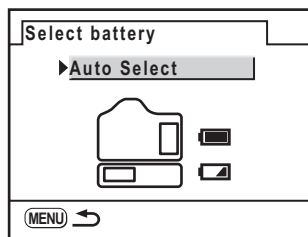

3 Press the four-way controller (▶).

Use the four-way controller (▲▼) to select from [Auto Select], [Body First] and [Grip First].

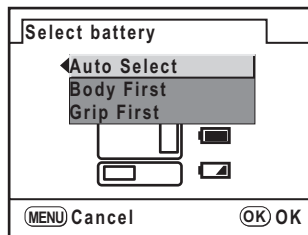

Auto Select	Priority is given to the battery with the most remaining power.
Body First/Grip First	Priority is given to the selected battery.

4 Press the OK button.

5 Press the MENU button twice.

The camera is ready to take a picture.



- If the battery is inserted into both the body and grip, the battery levels of both are checked when the power is turned on. Regardless of the [Select Battery] setting, both batteries are slightly used.
- When the currently selected battery runs out as a result of the check, [Battery depleted] appears on the monitor. Turn the camera off and on again, and the camera will switch to the remaining battery.
- You can check the battery usage condition on the detailed information display in Capture mode. (p.24)

Using Pixel Mapping

Pixel mapping is a function for mapping out and correcting for defective pixels in the CMOS sensor.

1 Select [Pixel Mapping] in the [**Set-up**] menu.

2 Press the four-way controller (**▶**).

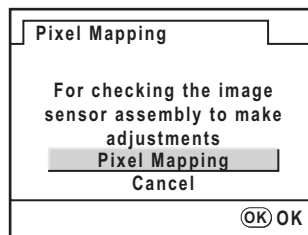

3 Press the four-way controller (**▲▼**) to select [Pixel Mapping] and press the **OK** button.

Defective pixels are mapped and corrected.



When the battery level is low, [Not enough battery remaining to activate Pixel Mapping] is displayed on the monitor. Use the AC adapter D-AC50 (optional) or use a battery with ample capacity remaining.

Selecting Capture Mode Settings to Save in the Camera

You can select which settings to save when the camera is turned off. The following settings can be saved: Flash mode, Drive mode, White Balance, Sensitivity, EV Compensation, Flash Exp. Comp., Auto Bracket, Playback Display and File No. The default setting is all [On].

1 Select [Memory] in the [📷 Rec. Mode] menu.

2 Press the four-way controller (▶).

The memory screen appears.

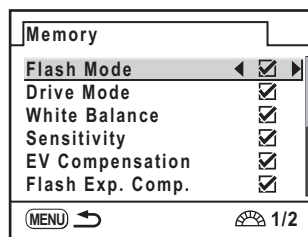

3 Use the four-way controller (▲ ▼) to choose an item.

4 Use the four-way controller (◀ ▶) to select (On) or (Off).

5 Press the MENU button twice.

The camera is ready to take a picture.



[File No.] sets whether to save a sequential number for the file name. See "Selecting the File Number Setting" (p.230).

11 Resetting to Default Settings

Resets the camera settings.

Resetting Rec. Mode/Playback/Set-up Menu ...	238
Resetting the Custom Function Menu	239
Resetting Other Settings	240

Resetting Rec. Mode/Playback/Set-up Menu

Settings in [📷 Rec. Mode] menu, [▶ Playback] menu and [⚙ Set-up] menu can be reset to default settings.

However, Date Adjust, Language/言語, Video Out, Text Size and the World Time city setting are not reset.

When the exposure mode is set to USER, [Reset USER setting] (p.240) is displayed. Set the mode dial to any setting other than USER.

1 Select [Reset] in the [⚙ Set-up] menu.

2 Use the four-way controller (▶) to display the Reset screen.

3 Use the four-way controller (▲▼) to select [Reset].

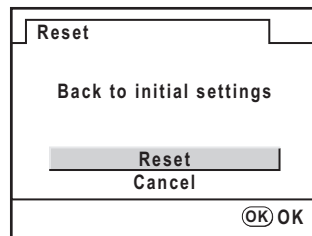

4 Press the OK button.

The settings are reset and the camera is ready to take or play back images.

Resetting the Custom Function Menu

Reset settings in [**C** Custom Setting] menu to default settings. Settings in [**Rec. Mode**] menu, [**Playback**] menu and [**Set-up**] menu are not reset.

- 1** Select [**Reset Custom Function**] in the [**C Custom Setting**] menu.
- 2** Use the four-way controller (**▶**) to display the **Reset Custom Function** screen.
- 3** Use the four-way controller (**▲ ▼**) to select [**Reset**].

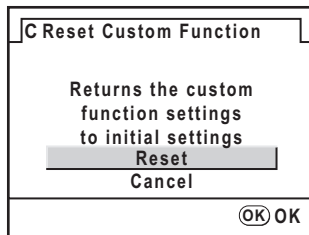



- 4** Press the **OK** button.

The settings are reset and the camera is ready to take or play back images.



Resetting Other Settings

Resetting Saved USER Settings

You can reset saved USER mode settings to their default settings.

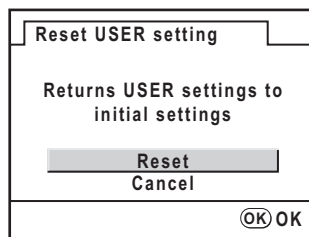
- 1** Set the mode dial to USER.
- 2** Select [Reset USER setting] in the [ Set-up] menu.
- 3** Use the four-way controller () to display the Reset USER setting screen.



- 4** Use the four-way controller ( ) to select [Reset].
- 5** Press the OK button.

The saved settings are reset and the camera is ready to take or play back images.

Resetting the File Name

If you changed the file name setting (p.231), you can reset this to the default setting.

- 1** Select [File Name] in the [ Set-up] menu and press the four-way controller (▶).
- 2** Press the four-way controller (▲▼) to select [Reset File Name] and press the four-way controller (▶).
- 3** Press the four-way controller (▲▼) to select [Reset] and press the OK button.
The file name is reset.
- 4** Press the MENU button twice.
The camera is ready to take or play back images.

Resetting the Saved AF Adjustment Value

You can delete the adjustment value saved with AF Adjustment (p.106).

- 1** Select [35. AF Adjustment] in the [C Custom Setting] menu and press the four-way controller (▶).
- 2** Press the four-way controller (▲▼) to select [On] and press the four-way controller (▶).
The AF Adjustment screen appears.
- 3** Use the four-way controller (▲▼) to select [Reset] and press the four-way controller (▶).
- 4** Use the four-way controller (▲▼) to select [Reset] and press the OK button.
The saved adjustment value is deleted and the camera is ready to take or play back images.

Memo



12 Appendix

Default Settings	244
Functions Available with Various Lens Combinations	249
Notes on [36. Using Aperture Ring]	251
Cleaning the CMOS Sensor	252
Optional Accessories	256
Error Messages	261
Troubleshooting	264
Main Specifications	266
Glossary	270
Index	275
WARRANTY POLICY	280

Default Settings

The table below lists the factory default settings.

Table notations are as follows.

The current setting (last memory) is saved when the camera is turned off.

Reset Setting

Yes : The setting returns to the default setting with the reset function (p.237).

No : The setting is saved even after reset.

[Rec. Mode] Menu

Item		Default Setting	Reset Setting	Page
Exposure Mode*		P (Hyper-program)	Yes	p.133
JPEG Recorded Pixels		 (4672×3104)	Yes	p.156
JPEG Quality		★★★ (Best)	Yes	p.157
File Format		JPEG	Yes	p.158
RAW file format		PEF	Yes	p.158
Extended Bracket	Type	Off	Yes	p.131
	White Balance	BA ±1	Yes	
	Saturation/Hue/ Contrast/Sharpness	±1	Yes	
Multi-exposure	Number of shots	Off	Yes	p.103
	Auto EV Adjust	<input type="checkbox"/> (Off)	Yes	
Interval Shooting	Interval	1 sec	Yes	p.120
	Number of Shots	1	Yes	
	Start Trigger	Now	Yes	
	Start Time	0:00	Yes	
Color Space		sRGB	Yes	p.167
RAW button	Cancel each time	<input checked="" type="checkbox"/> (On)	Yes	p.159
	JPEG/RAW/RAW+ File Format	All RAW+	Yes	
Memory		All <input checked="" type="checkbox"/> (On)	Yes	p.236
Input Focal Length		35 (Focal Length)	Yes	p.67

* Appears only when Mode dial is set to **USER** (USER).

[▶ Playback] Menu

Item		Default Setting	Reset Setting	Page
Playback display	Bright/Dark area	<input type="checkbox"/> (Off)	Yes	p.184
	Quick Zoom	<input type="checkbox"/> (Off)	Yes	
Instant Review	Display Time	1 sec	Yes	p.227
	Histogram	<input type="checkbox"/> (Off)	Yes	
	Bright/Dark area	<input type="checkbox"/> (Off)	Yes	
Live View	Show Grid	<input type="checkbox"/> (Off)	Yes	p.228
	AF Frame Display	<input type="checkbox"/> (Off)	Yes	
Digital Preview	Histogram	<input type="checkbox"/> (Off)	Yes	p.229
	Bright/Dark area	<input type="checkbox"/> (Off)	Yes	
Slideshow	Interval	3 sec	Yes	p.181
	Repeat Playback	<input type="checkbox"/> (Off)	Yes	

[↶ Set-up] Menu

Item		Default Setting	Reset Setting	Page
USER		—	Yes ^{*1}	p.133
Format		—	—	p.218
Beep		All <input checked="" type="checkbox"/> (On)	Yes	p.219
Date Adjust		According to default setting	No	p.220
World Time	World Time setting	(Hometown)	Yes	p.221
	Hometown (City)	According to default setting	No	
	Hometown (DST)	According to default setting	No	
	Destination (City)	Same as Hometown	No	
	Destination (DST)	Same as Hometown	No	
Language/言語		According to default setting	No	p.224
Text Size		According to default setting	No	p.225
Guide display		3 sec	Yes	p.225
Brightness Level		±0	Yes	p.226

Item		Default Setting	Reset Setting	Page
LCD Color Tuning		±0	Yes	p.226
Video Out		According to default setting	No	p.233
USB Connection		PC	Yes	p.208
Auto Power Off		1 min	Yes	p.233
Folder Name		Date	Yes	p.230
File Name		IMGP	Yes*2	p.231
Select battery		Auto Select	Yes	p.234
Pixel Mapping		—	—	p.235
Dust Alert		—	—	p.252
Dust Removal	Dust Removal	—	—	p.252
	Start-up action	<input type="checkbox"/> (Off)	Yes	
Sensor Cleaning		—	—	p.254
Reset		—	—	p.238
Reset USER setting		—	—	p.240

*1 Reset only for [Reset USER setting] displayed when Mode dial is set to **USER** (USER).

*2 Reset only for [Reset File Name] in the [File Name] menu.

[C Custom Setting] Menu

Item		Default Setting	Reset Setting	Page
Settings		<input type="checkbox"/> (Off)	Yes	p.73
1. Program Line		Normal	Yes	p.82
2. EV Steps		1/2 EV Steps	Yes	p.101
3. Sensitivity Steps		1 EV Steps	Yes	p.78
4. Expand sensitivity		Off	Yes	p.78
5. Meter Operating Time		10 sec	Yes	p.99
6. AE-L with AF locked		Off	Yes	p.110
7. Link AF Point and AE		Off	Yes	p.99
8. One-Push Bracketing		Off	Yes	p.130
9. Auto Bracketing order		0 - +	Yes	p.129
10. Auto EV Compensation		Off	Yes	—
11. WB when using flash		Unchanged	Yes	p.161
12. WB Adjustable Range		Auto Adjustment	Yes	p.161

Item	Default Setting	Reset Setting	Page
13. AF Button Function	Enable AF	Yes	p.112
14. AF by Press Halfway	On	Yes	–
15. Superimpose AF Area	On	Yes	p.107
16. AF in remote control	Off	Yes	p.74
17. Slow Shutter Speed NR	Auto	Yes	p.80
18. High-ISO Noise Reduction	Off	Yes	p.80
19. Color temp. steps	Kelvin	Yes	p.166
20. e-dial in Program	Front: Tv Rear: Av	Yes	–
21. e-dial in Sv mode	Front: — Rear: ISO	Yes	–
22. e-dial in Tv mode	Front: Tv Rear: —	Yes	–
23. e-dial in Av mode	Front: — Rear: Av	Yes	–
24. e-dial in TAv & M	Front: Tv Rear: Av	Yes	–
25. e-dial in B & X	Front: — Rear: Av	Yes	–
26. Green button in TAv & M	Program Line	Yes	p.92, p.95
27. Illuminate LCD panel	On	Yes	p.29
28. Release when Charging	Off	Yes	p.137
29. Flash in Wireless Mode	On	Yes	p.146
30. Preview Method	Live View	Yes	p.113
31. Display Sensitivity	Off	Yes	–
32. Saving rotation info	On	Yes	–
33. Auto Image Rotation	On	Yes	–
34. Catch-in focus	Off	Yes	p.112
35. AF Adjustment	Off	Yes ^{*1}	p.106
36. Using aperture ring	Prohibited	Yes	p.251
Reset Custom Function ^{*2}	—	—	p.239

*1 The saved adjustment value is reset only for [Reset] in the [35. AF Adjustment] menu.

*2 The [C Custom Setting] menu settings are reset.

Fn Menu

Item	Default Setting	Reset Setting	Page
Drive Mode	<input type="checkbox"/> (Single frame shooting)	Yes	p.117, p.122, p.125
Flash Mode	(Flash On) ^{*1}	Yes	p.60
White Balance	AWB (Auto)	Yes	p.160
ISO Sensitivity	AUTO (ISO 100 - 400)	Yes	p.78
Custom Image	Natural ^{*2}	Yes	p.154
DPOF Settings	—	No	p.204
Digital Filter ^{*3}	B&W	Yes	p.194
Slideshow	3 sec	Yes	p.179
RAW Display	Recorded Pixels: 14.6 M Quality Level: ★★★ Sensitivity: ±0	Yes	p.197
Image Comparison	—	—	p.178

*1 Automatically discharged in Green Mode.

*2 [Bright] when [Language/言語] is set to a language other than Japanese.

*3 The filter color and frequency settings can be saved or reset.

Functions Available with Various Lens Combinations

Lenses that can be used with this camera

Only DA and FA J lenses and D FA/FA/F/A lenses having an **A** position on the aperture ring can be used with this camera. Refer to Notes on [36. Using Aperture Ring] (p.251) for other lenses and D FA/FA/F/A lenses with aperture ring set to a position other than **A**.

Function \ Lens [Mount type]	DA/D FA/ FA J/FA lens [KAF, KAF2] ^{*3}	F lens [KAF] ^{*3}	A lens [KA]
Autofocus (Lens only) (With AF adapter 1.7x) ^{*1}	Yes —	Yes —	— Yes ^{*5}
Manual focus (With the focus indicator) ^{*2} (With Matte field)	Yes Yes	Yes Yes	Yes Yes
Eleven AF points	Yes	Yes	No ^{*5}
Power zoom	Yes ^{*6}	—	—
Aperture Priority Automatic Exposure	Yes	Yes	Yes
Shutter Priority Automatic Exposure	Yes	Yes	Yes
Manual Exposure	Yes	Yes	Yes
P-TTL Auto Flash ^{*4}	Yes	Yes	Yes
Multi (16-segment) metering	Yes	Yes	Yes
Automatic lens focal length acquirement when using the Shake Reduction function	Yes	Yes	No

Yes : Functions are available when the aperture ring is set to the **A** position.

No : Functions are unavailable.

*1 Lenses with a maximum aperture of f/2.8 or brighter. Only available at **A** position.

*2 Lenses with a maximum aperture of f/5.6 or brighter.

*3 To use an F/FA soft 85 mm f/2.8 lens or FA soft 28 mm f/2.8 lens, set [36. Using aperture ring] (p.75) to [Permitted] in the [C Custom Setting] menu. Pictures can be taken with the aperture you set, but only within manual aperture range.

*4 When using the built-in flash and AF540FGZ/AF360FGZ/AF200FG.

*5 The AF point becomes  (Center).

*6 Only available with KAF2 mount FA lenses.

Lens names and mount names

DA lenses with an ultrasonic motor and FA zoom lenses with power zoom use the K_{AF2} mount.

FA prime lenses (non-zoom lenses), DA lenses without ultrasonic motors and D FA, FA J and F lenses use the K_{AF} mount.

See the lens manual for details.

Lenses and accessories that cannot be used with this camera

When aperture ring is set at other than the **A** (Auto) position or a lens without an **A** position or accessories such as an auto extension tube or auto bellows are used, camera does not operate unless [36. Using aperture ring] (p.75) is set to [Permitted] in the [**C** Custom Setting] menu. Refer to Notes on [36. Using Aperture Ring] (p.251) for restriction that apply when [36. Using aperture ring] is set to [Permitted] in the [**C** Custom Setting] menu.

All camera exposure modes are available when using DA/FA J or lenses with an Aperture **A** position set to the **A** position.

Lens and Built-in Flash

The built-in flash cannot be regulated and fully fires when pre A lenses or soft focus lenses are used.

Note that the built-in flash cannot be used as an Auto Flash.

Notes on [36. Using Aperture Ring]

Aperture Ring Use

When [36. Using aperture ring] is set to [Permitted] in [C Custom Setting] menu (p.75), the shutter can be released even if the aperture ring of the D FA, FA, F or A lens is not set to the **A** position or a lens without a **A** position is attached. However, the features will be restricted as shown in the table below.



The camera operates in **Av** (Aperture Priority) mode even if the mode dial is at **M**, **P**, **Sv**, **Tv** or **TAv** when the aperture is set to a value other than **A**.

Lens Used	Exposure Mode	Restriction
D FA, FA, F, A, M (lens only or with auto diaphragm accessories such as auto extension tube K)	Av (Aperture Priority) mode	The aperture remains open regardless of the aperture ring position. The shutter speed changes in relation to the open aperture but an exposure error may occur. In the viewfinder, [F--] appears for the aperture indicator.
D FA, FA, F, A, M, S (with diaphragm accessories such as extension tube K)	Av (Aperture Priority) mode	Pictures can be taken with the specified aperture value but an exposure error may occur. In the viewfinder, [F--] appears for the aperture indicator.
Manual diaphragm lens such as reflex lens (lens only)	Av (Aperture Priority) mode	
FA, F soft 85mm FA soft 28mm (lens only)	Av (Aperture Priority) mode	Pictures can be taken with the specified aperture value in the manual aperture range. In the viewfinder, [F--] appears for the aperture indicator. When depth of field is checked (Optical Preview), AE Metering is switched on. Exposure check is possible.
All lenses	M (Hyper-manual) mode	Pictures can be taken with the set aperture value and shutter speed. In the viewfinder, [F--] appears for the aperture indicator. When depth of field is checked (Optical Preview), AE Metering is switched on. Exposure check is possible.

Cleaning the CMOS Sensor

Shadows may appear in the image for white backgrounds and other shooting conditions if the CMOS sensor becomes dirty or dusty. This indicates that the CMOS sensor must be cleaned.

Removing Dust by Shaking the CMOS Sensor

The Dust Removal function shakes the CMOS sensor to remove dust that has collected.

- 1 Select [Dust Removal] in the [**Set-up**] menu and press the four-way controller (▶).

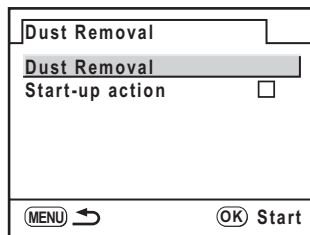

- 2 Press the OK button.

The Dust Removal function is activated by shaking the CMOS sensor. Select [Start-up action] and use the four-way controller (◀▶) to select (On) to turn Dust Removal on every time the camera is turned on.

Detecting Dust on the CMOS Sensor (Dust Alert)

Dust Alert is a function that detects dust adhering to the CMOS sensor and visually displays the location of the dust.

You can save the detected image and display it when performing sensor cleaning (p.254).

Be sure to have a lens attached when using the Dust Alert function.

- 1** Select [Dust Alert] in the [**Set-up**] menu.

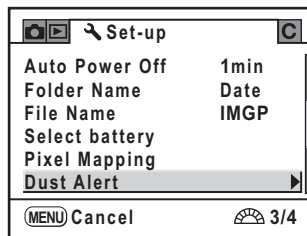

- 2** Press the four-way controller (**▶**).

- 3** Point the lens at a white wall or other uniform surface and press the shutter release button fully.

After image processing is performed, the Dust Alert screen appears.

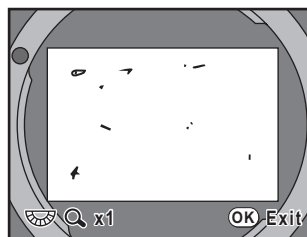

- 4** Press the **OK** button.

The image is saved and Dust Alert is exited.



- The exposure time may be extremely long when using the Dust Alert function. Note that if the direction of the lens is changed before processing is complete, dust will not be detected properly.
- The Dust Alert image can only be displayed during sensor cleaning within 30 minutes from the time the image is saved. If 30 minutes elapse, save a new Dust Alert image and then perform sensor cleaning.
- The saved Dust Alert image cannot be displayed in Playback mode.
- Dust Alert image cannot be saved when an SD Memory Card is not inserted.



- If [NG] is displayed in Step 3 and the camera is unable to detect dust, press the **OK** button and take another picture.
- Regardless of the camera settings, a picture will be taken with specific shooting conditions in Step 3.
- When using a lens with an aperture ring, make sure the aperture ring is set to the **A** position.
- Press the **INFO** button or turn the rear e-dial when displaying the Dust Alert image to view it at full screen display.

Removing Dust with a Blower

Raise the mirror up and open the shutter to clean with a blower. Please contact PENTAX Service Center for professional cleaning because the CMOS sensor is a precision part. Cleaning services involve a fee. You can use the Imagesensor Cleaning Kit O-ICK1 (optional) when cleaning the CMOS.



- Do not use a spray type blower.
- Do not clean the sensor when the exposure mode is set to **B** (Bulb) mode.
- Always cap the lens mount area to prevent dirt and dust from accumulating on the CMOS sensor when no lens is on the camera.
- When the battery level is low, [Not enough battery remaining to clean sensor] is displayed on the monitor.
- If you are not using the AC adapter D-AC50, please use a battery with ample capacity remaining. If the battery capacity becomes low during cleaning, a message will be displayed on the monitor and a warning beep will sound. Please stop cleaning immediately.
- Do not put the tip of the blower inside the lens mount area. If the power is turned off, this could cause damage to the shutter, CMOS sensor or the mirror.



- It is recommended to use the AC adapter D-AC50 (optional) when cleaning the sensor.
- The self-timer lamp blinks and [CIn] appears on the LCD panel while cleaning the sensor.
- This camera features a CMOS sensor shifting shake reduction system, and it may generate a vibration sound while cleaning the CMOS sensor. It is not a malfunction.

- 1 Turn the camera off and remove the lens.**
- 2 Turn the camera on.**
- 3 Select [Sensor Cleaning] in the [Set-up] menu.**

4 Press the four-way controller (▶).

The Sensor Cleaning screen appears.

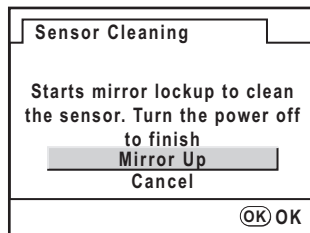
5 Use the four-way controller (▲▼) to select [Mirror Up].

6 Press the OK button.

The mirror is locked in the up position.

If you used Dust Alert to detect dust on the sensor within the last 30 minutes, the Dust Alert image appears on the monitor. Clean the sensor while checking the location of the dust.

7 Clean the CMOS sensor.

Use a brush-less blower to remove dirt and dust from the CMOS sensor. Using a blower with a brush may scratch the CMOS sensor. Do not wipe the CMOS sensor with a cloth.

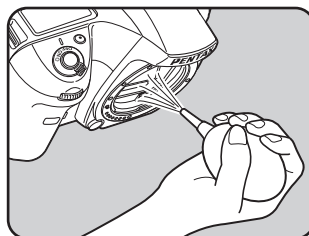

8 Turn off the camera.

9 Attach the lens after the mirror returns to its original position.

Optional Accessories

A number of dedicated accessories are available for this camera. Please contact a PENTAX Service Center for details regarding accessories. Products marked with an asterisk (*) are the same as those supplied with the camera.

Battery Grip D-BG2

The Battery Grip has features such as a shutter release button, front e-dial, rear e-dial, and **AE-L** button to accommodate shooting vertically.



Power Supply Accessories

AC Adapter D-AC50

Lets you power your camera with the outlet when combined with the AC plug cord.

Battery Charger D-BC50 (*)

Rechargeable Lithium-ion Battery D-LI50 (*)

AC plug cord (*)

Flash Accessories

Auto Flash AF540FGZ

Auto Flash AF360FGZ

The AF540FGZ and AF360FGZ are P-TTL auto flash units with a maximum guide number of approximately 54 and approximately 36 (ISO 100/m), respectively. Their features include slave-sync flash, contrast-control-sync flash, auto flash, high-speed sync flash, wireless flash, slow-speed sync and trailing curtain sync flash.

Auto Flash AF200FG

The AF200FG is a P-TTL auto flash unit with a maximum guide number of approximately 20 (ISO 100/m). It features contrast-control-sync flash and slow-speed sync flash when combined with the AF540FGZ or AF360FGZ unit.



AF540FGZ



AF360FGZ



AF200FG

Hot Shoe Adapter Fc

Extension Cord F5P

Off-camera Shoe Adapter F

Use the adapters and cords to use the external flash away from the camera.



Hot Shoe Adapter Fc



Off-camera Shoe Adapter F

Off-camera Shoe Clip CL-10

When using the AF540FGZ or AF360FGZ as a wireless flash, this large clip is used for setting the external flash on a desk or table.

**For Viewfinder****Magnifier Eyecup O-ME53**

This viewfinder accessory is for magnifying up to 1.18 times. When the eyecup is attached to the **K20D** with a viewfinder magnification of 0.95 times, the combined magnification becomes 1.12 times, making manual focusing much easier.

**Magnifier F_B**

This viewfinder accessory is for magnifying the central area of the viewfinder 2×. You can see the entire view by simply flipping up the accessory from the eyepiece, as it is a hinge-type magnifier.

**Ref-converter A**

This is an accessory that changes the viewfinder viewing angle at 90° intervals. The viewfinder magnification can be switched between 1× and 2×.

**Diopter correction lens adapter M**

This accessory adjusts the diopter. Install it on the viewfinder. If it is difficult to see the viewfinder image clearly, choose one of the eight correction lens adapter M of approximately -5 to $+3$ m⁻¹ (per meter).



ME Viewfinder Cap (*)**Eyecup F_P (*)****Interchangeable Focusing Screen**

LF-80: AF Frame Matte (standard)

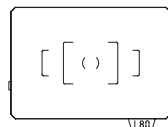

LL-80: AF Divided Matte

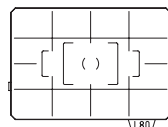

LI-80: AF Scale Matte

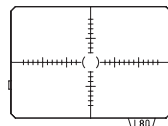
**Cable Switch CS-205**

Connect to the cable switch terminal and operate the camera shutter release button. The cord length is 0.5 m.

**Remote Control F**

Lets you shoot pictures from within 5 m of the front or back of the camera.



Camera Case/Strap

Camera Case O-CC55



Camera Strap O-ST53 (*)

Imagesensor Cleaning Kit O-ICK1

Clean the optical parts such as the CMOS sensor and lens of this camera.

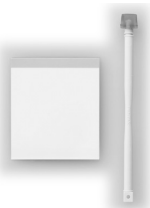

Others

Body Mount Cap K

Hot Shoe Cover Fκ (*)

USB Cable I-USB17 (*)

Video Cable I-VC28 (*)

Sync Socket 2P Cap (*)

Error Messages

Error Message	Description
Memory card full	The SD Memory Card is full and no more images can be saved. Insert a new SD Memory Card or delete unwanted images. (p.40, p.70) You may be able to save new images by converting to JPEG format or changing the JPEG record pixels or JPEG quality setting. (p.156, p.157)
No image	There are no images for playback on the SD Memory Card.
Camera cannot display this image	You are trying to play back an image in a format not supported by this camera. You may be able to play it back on another brand of camera or your computer.
No card in the camera	The SD Memory Card is not inserted in the camera. (p.40)
Memory card error	The SD Memory Card has a problem, and image capture and playback are impossible. It may be viewable on a PC but not with this camera.
Card not formatted	The SD Memory Card you have inserted is unformatted or has been formatted on a computer or other device and is not compatible with this camera. Use the card after formatting it with this camera. (p.218)
Card locked	A locked SD Memory Card is inserted in the camera. Unlock the SD Memory Card. (p.41)
The card is electronically locked	Data is protected by the SD Memory Card security feature.
This image cannot be enlarged	You are trying to enlarge an image that cannot be enlarged.
This image is protected	You are trying to delete an image that is protected. Remove protection from the image. (p.189)
Battery depleted	The battery is exhausted. Install a charged battery in the camera. (p.35)
Not enough battery remaining to clean sensor	Appears during sensor cleaning if the battery level is insufficient. Replace the battery with a charged one or use an AC adaptor D-AC50 (optional). (p.39)

Error Message	Description
Not enough battery remaining to activate Pixel Mapping	Appears during pixel mapping if the battery level is insufficient. Replace the battery with a charged one or use an AC adaptor D-AC50 (optional). (p.39)
Image folder cannot be created	The maximum folder number (999) and file number (9999) are being used, and no more images can be saved. Insert a new SD Memory Card or format the card. (p.218)
The image is not stored	The image could not be saved because of an SD Memory Card error.
Settings not stored	The DPOF settings or rotated image could not be saved because SD Memory Card is full. Delete unwanted images and perform DPOF settings or rotation again. (p.70)
NG	The camera was unable to measure the manual white balance or detect dust on the sensor. Try the operation again. (p.163, p.252)
Rotation information cannot be saved to this image	New rotation information cannot be saved to an image without rotation information.
No more images can be selected	You cannot select 100 or more images to delete or edit at a time. (p.186, p.198)
This RAW file cannot be developed	RAW files captured with other cameras cannot be edited on this camera.
This image cannot be filtered	Appears when digital filter is started from Fn menu for images captured with other cameras.
No DPOF files	No file set with DPOF. Set DPOF and then print. (p.204)
Printer error	There is an error with the printer and the file cannot be printed. Fix all the errors and try printing again.
No paper in the printer	Printer has run out of paper. Put paper in the printer and print.
Printer settings are changed	The camera received notification that the printer status has changed. Press the OK button to reconnect to the printer.
Low paper level in the printer	Printer is running out of paper. This appears when this signal is received from the printer. After two seconds, the printer resumes printing.
Low ink level in the printer	Printer is running out of ink. This appears when this signal is received from the printer. After two seconds, the printer resumes printing.

Error Message	Description
No ink in the printer	Printer has run out of ink. Replace ink and print.
Paper stuck in the printer	Paper is jammed in the printer. Remove paper and print.
Data error	A data error has occurred during printing.
Turn the power off	This appears when exiting the PictBridge mode. Turn the main switch off.

Troubleshooting

We recommend checking the following items before contacting a service center.

Problem	Cause	Remedy
The camera does not turn on	The battery is not installed	Check if a battery is installed. If not, install a charged battery.
	The battery power is low	Replace with a charged battery or use the AC adapter D-AC50 (optional). (p.39)
The shutter does not release	The lens aperture ring setting is other than the A position	Set the lens aperture ring to the A position (p.84) or select [Permitted] in [36. Using aperture ring] in the [C Custom Setting] menu (p.251).
	The flash is charging	Wait until charging is finished.
	There is no available space on the SD Memory Card	Insert an SD Memory Card with available space or delete unwanted images. (p.40, p.70)
	Recording	Wait until recording is finished.
The Autofocus does not work	The subject is difficult to focus on	Autofocus cannot focus well on subjects that have low contrast (the sky, white walls), dark colors, intricate designs, rapidly-moving objects or scenery shot through a window or a net-like pattern. Lock focus on another object located at the same distance as your subject (press the shutter release button halfway), then aim at target and press the shutter release button fully. Alternatively, use manual focus. (p.110)
	The subject is not in the focusing area	Position the subject in the focus frame in the middle of the viewfinder. If the subject is outside the focusing area, aim the camera at the subject and lock the focus (press the shutter release button halfway), then compose a picture and press the shutter release button fully.
	The subject is too close	Move away from the subject and take a picture.
	The focus mode is set to MF	Set the focus mode lever to AF.S (Single mode). (p.104)
	The focus mode is set to AF.C (Continuous mode)	Autofocus is not locked (focus lock) when the focus mode is set to AF.C . The camera will continue focusing on the subject while the shutter release button is pressed halfway. If there is a subject that you wish to focus on, slide the focus mode lever to AF.S and use the focus lock.

Problem	Cause	Remedy
AE lock function does not operate	AE lock is not available when set to ■ (Green), B (Bulb) or X (Flash X-sync speed) mode	Use AE lock with any setting other than ■ (Green), B (Bulb) or X (Flash X-sync speed) mode.
The flash does not discharge	The Capture mode is set to ■ (Green) mode	Only ⚡^A (Auto discharge) and ⚡^AⓈ (Auto flash+Redeye reduct) are available for the Flash Mode when the Capture mode is ■ . The flash will not discharge when the subject is bright in these modes. In the Capture modes other than ■ , only the flash mode that discharges every time the flash recharges is available. Try different Capture modes.
The USB connection with a computer does not work properly*	The Transfer Mode is set to [PictBridge]	Set [USB Connection] in the [⚡ Set-up] menu to [PC].
The USB connection with a printer does not work properly	The Transfer Mode is set to [PC]	Set [USB Connection] in the [⚡ Set-up] menu to [PictBridge]. (p.208)
Shake Reduction does not work	The Shake Reduction function is off	Turn on the Shake Reduction switch.
	The Shake Reduction function is not set properly	If a lens for which focal length information cannot be acquired is used, set the [Focal Length] on the [Input Focal Length] menu. (p.67)
	Shutter speed is too low for the Shake Reduction function to be effective when panning or shooting night scenes, etc.	Turn off the Shake Reduction function and use a tripod.
	The subject is too close	Move away from the subject, or turn off the Shake Reduction function and use a tripod.

In rare cases, the camera may not operate correctly due to static electricity. This can be remedied by taking the battery out and putting it back in again. When the mirror remains in the up position, take the battery out and put it back in again. Then, turn the power on. The mirror will retract. After the procedure is done, if the camera operates correctly, it does not require any repairs.

* Refer to p.11 of the "PENTAX PHOTO Browser 3/PENTAX PHOTO Laboratory 3 Operating Manual" for details on connecting the camera to a PC.

Main Specifications

Type	TTL autofocus, auto-exposure SLR digital-still camera with built-in retractable P-TTL flash
Effective Pixels	Approx. 14.6 megapixels
Sensor	Total pixels approx. 15.07 megapixels, CMOS with a primary color filter
Recorded Pixels	14.6M (RAW: 4672×3104 pixels), 14.6M (JPEG: 4672×3104 pixels), 10M (3872×2592 pixels), 6M (3008×2000 pixels), 2M (1824×1216 pixels)
Sensitivity (Standard output sensitivity)	Auto, ISO 100 to 3200 (Standard output sensitivity) (EV steps can be set to 1 EV, 1/2 EV or 1/3 EV), ISO 6400 is available with the custom function setting, up to ISO 1600 is available during B
File Format	RAW (PEF/DNG), JPEG (Exif 2.21), DCF 2.0 compliant, DPOF compatible, Print Image Matching III compatible, RAW+JPEG simultaneous capturing compatible
JPEG Quality	★★★★ (Premium), ★★★ (Best), ★★ (Better), and ★ (Good)
Storage Medium	SD Memory Card, SDHC Memory Card
Number of Shots	



Recorded Pixels	File Format/ JPEG Quality	Capacity					
		4GB	2GB	1GB	512MB	256MB	128MB
14.6M 4672×3104	RAW (PEF)	Approx. 162	Approx. 82	Approx. 40	Approx. 20	Approx. 10	Approx. 5
	RAW (DNG)	Approx. 161	Approx. 82	Approx. 40	Approx. 20	Approx. 10	Approx. 5
14.6M 4672×3104	★★★★	Approx. 272	Approx. 138	Approx. 68	Approx. 34	Approx. 17	Approx. 8
	★★★	Approx. 469	Approx. 239	Approx. 117	Approx. 58	Approx. 29	Approx. 15
	★★	Approx. 843	Approx. 429	Approx. 212	Approx. 105	Approx. 53	Approx. 27
	★	Approx. 1630	Approx. 830	Approx. 411	Approx. 205	Approx. 103	Approx. 53
10M 3872×2592	★★★★	Approx. 404	Approx. 206	Approx. 101	Approx. 50	Approx. 25	Approx. 13
	★★★	Approx. 674	Approx. 343	Approx. 168	Approx. 84	Approx. 42	Approx. 21
	★★	Approx. 1183	Approx. 602	Approx. 296	Approx. 148	Approx. 74	Approx. 38
	★	Approx. 2463	Approx. 1254	Approx. 616	Approx. 308	Approx. 155	Approx. 79
6M 3008×2000	★★★★	Approx. 705	Approx. 359	Approx. 176	Approx. 88	Approx. 44	Approx. 22
	★★★	Approx. 1138	Approx. 579	Approx. 285	Approx. 142	Approx. 71	Approx. 36
	★★	Approx. 1946	Approx. 991	Approx. 491	Approx. 245	Approx. 123	Approx. 63
	★	Approx. 3657	Approx. 1862	Approx. 915	Approx. 457	Approx. 230	Approx. 118

Recorded Pixels	File Format/ JPEG Quality	Capacity					
		4GB	2GB	1GB	512MB	256MB	128MB
1824×1216	★★★★	Approx. 1828	Approx. 931	Approx. 461	Approx. 230	Approx. 116	Approx. 59
	★★★	Approx. 2943	Approx. 1499	Approx. 737	Approx. 368	Approx. 185	Approx. 95
	★★	Approx. 4827	Approx. 2458	Approx. 1233	Approx. 616	Approx. 310	Approx. 159
	★	Approx. 8620	Approx. 4390	Approx. 2238	Approx. 1118	Approx. 564	Approx. 289

JPEG Quality (Compression): ★★★★★ (Premium) = 1/2.8, ★★★ (Best) = 1/4.5, ★★ (Better) = 1/8, ★ (Good) = 1/16

White Balance	Auto, Daylight, Shade, Cloudy, Fluorescent Light (D: Daylight, N: Neutral White, W: White), Tungsten Light, Flash, Manual, Color Temperature (3 types), fine tuning available
Monitor	2.7 inch wide viewing field TFT color LCD with approx. 230,000 dots, brightness adjustment function, color adjusting function
Playback Function	Single frame, 4-image display, 9-image display, 16-image display, zoom display (up to 32 times, scrolling possible), image comparison, rotating, folder display, slideshow, histogram, bright/dark area
Digital Filter	B&W, Sepia, Color, Extract Color, Soft, Illustration, HDR, Slim, Brightness (only for processing after shooting)
Exposure Mode	USER , Green, P Hyper-program, Sv Sensitivity priority, Tv Shutter priority, Av Aperture priority, TAv Shutter & Aperture priority, M Hyper-manual, B Bulb, X Flash X-sync speed
Shutter	Electronically controlled vertical-run focal-plane shutter, Speed range (1) Auto 1/4000 to 30 sec. (stepless), (2) Manual 1/4000 to 30 sec. (1/2 EV step or 1/3 EV step), Bulb, Electromagnetic release, Shutter lock by setting Main switch in OFF position.
Lens Mount	PENTAX KAF2 bayonet mount (AF coupler, lens information contacts, K-mount with power contacts)
Lens Used	PENTAX KAF2 mount lenses (power zoom compatible), KAF mount lenses, KA mount lenses
Autofocus System	TTL phase-matching autofocus system (SAFOX VIII), AF operational brightness range: EV -1 to 18 (at ISO 100 with f/1.4 lens), Focus lock available, Focus Mode: A.F.S (Single)/ A.F.C (Continuous)/ MF , Adjustable AF point
Viewfinder	Pentaprism Finder, Interchangeable Natural-Bright-Matte II focusing screen, Field of view: approx. 95%, Magnification: approx. 0.95× (with 50 mm f/1.4 lens at ∞), Diopter: approx. -2.5m ⁻¹ to +1.5m ⁻¹ (per meter)
Viewfinder Indication	Focus information: ● is lit when in-focus and blinking when unable to focus, ⚡ is lit = Built-in flash ready, ⚡ is blinking = Flash should be used or incompatible lens is being used, Shutter speed, Confirm Sensitivity, Aperture value, e-dial enabled indicator, * = AE lock, Capacity remaining, ☒ = EV compensation, ⚡± = Flash compensation, MF = Manual focus, Shake Reduction display, EV bar, RAW/RAW+

LCD Panel Display	<p>⚡ is lit = Built-in flash ready, ⚡ is blinking = Flash should be used or incompatible lens is being used, A = Auto discharge, 👁 = Redeye reduction, SLOW = Slow-speed sync, ☐ = Single frame shooting, 📷 = Continuous shooting, ⌚ = Self-timer, 📡 = Remote control shooting, 🔋 = Battery exhaustion warning, 📷 = Auto bracket exposure (EV steps can be set to 1/2 EV or 1/3 EV), ⚡ = Flash exposure compensation, Confirm sensitivity, Shutter speed, Aperture value, White Balance, Remaining capacity, 📷 = EV compensation, PC (mass storage)/ Pb (PictBridge) appears when the USB cable is connected, EV bar, RAW, RAW +</p>
Preview Function	<p>Live View: TTL method using the image sensor, Zoom Display and Show Grid are usable Optical Preview: Depth of field confirmation (electronically controlled and usable in all exposure modes) Digital Preview: Composition, exposure, focus and white balance confirmation</p>
Continuous shooting (Hi/Lo)	Up to approx. 3 fps, JPEG: up to 38 frames (Hi) / until SD Memory Card is full (Lo), RAW: up to 14 frames (PEF) / up to 16 frames (DNG)
Burst Shooting	Approx. 21 fps, JPEG (1.6M /★★★): up to approx. 115 frames
Self-timer	Electronically controlled with delay time of 12 sec./2 sec. (with mirror up function). Start by pressing the shutter release button. Operation confirmation: Possible to set beep. Can be cancelled after operation
Remote Control	PENTAX Remote Control F (optional) Release shutter immediately or three seconds after pressing the remote control shutter button, Remote Continuous Shooting
Mirror	Quick-return mirror, mirror up function (2 sec. self-timer)
Custom Image	Image Tone (6 types), Saturation/Filter Effect, Hue/Toning, Contrast, Sharpness
Exposure Bracket	Three or five frames (underexposed, proper exposure and overexposed) are shot continuously with exposure bracketing. (Selectable between 1/2 EV and 1/3 EV for EV steps)
Extended Bracket	Three frames are saved continuously with white balance, saturation, hue, contrast and sharpness bracketing.
Multi-exposure	Select the number of shots between 2 and 9 (Auto EV Adjust can be set according to the number of shots)
Exposure Meter/ Exposure Range	TTL multi (16-segment metering), Exposure range from EV 0 to EV 21 at ISO 100, with 50 mm f/1.4 lens, Center-weighted and Spot metering mode can be set
EV Compensation	±3 EV (1/2 EV Steps), ±2 EV (1/3 EV Steps), EV Steps can be selected
AE Lock	Button type (timer type: two times the meter operating time set in Custom Setting) Continuous as long as the shutter button is halfway pressed.

Built-in Flash	P-TTL built-in flash with serial control, GN approx. 13 (ISO 100 • m), Angles of coverage: 18 mm lens angle of view, Flash synchronization speed range at 1/180 sec. and slower, Daylight-sync flash, Slow-speed-sync flash, ISO range = P-TTL: 100 to 6400
External Flash Sync	Hot shoe with X -contact, which couples with PENTAX dedicated auto flashes, ISO range = P-TTL: 100 to 1600, Automatic flash, Red-eye reduction flash function, High-speed-sync, wireless-sync with PENTAX dedicated flash.
Custom Function	36 functions can be set
Time Function	World Time settings for 75 cities (28 time zones)
Dust Removal	SP coating and CMOS sensor operations for dust removal. Can be set to operate when the camera is turned on.
Power	Rechargeable lithium-ion battery D-LI50, AC adapter D-AC50 (optional)
Battery Life (23°C)	Number of recordable images: approx. 740 images (without flash) ^{*1} / approx. 530 images (50% flash usage) ^{*2} , playback time: approx. 330 minutes ^{*1} ^{*1} The number of recordable images (without flash) and playback time are based on PENTAX measuring conditions. Some deviation from the above figures may occur in actual use depending on usage conditions. ^{*2} The number of recordable images (50% flash usage) is based on measuring conditions in accordance with CIPA standards. Some deviation from the above figures may occur in actual use depending on usage conditions.
Battery Exhaustion	Battery exhaustion symbol  is lit. (The shutter is locked and no indication appears in the viewfinder when  starts blinking.)
In/Out Port	USB/Video terminal (USB 2.0 (high speed compatible)), DC input terminal, Cable switch terminal, X-sync socket
Video Output Format	NTSC/PAL
PictBridge	Compatible printer PictBridge-compatible printer Print mode Single Image, All Images, DPOF AUTOPRINT
Dimensions and Weight	Approx. 141.5 mm (W) × 101 mm (H) × 70 mm (D) (excluding protrusions) 715 g (body only), 800 g (including a battery and an SD Memory Card)
Accessories	Hot shoe cover Fk, Eyecup Fp, ME viewfinder cap, Sync socket 2P cap, Body mount cover, USB Cable I-USB17, Video cable I-VC28, Software (CD-ROM) S-SW74 (PENTAX PHOTO Browser 3/PENTAX PHOTO Laboratory 3), S-SW75 (PENTAX REMOTE Assistant 3), Strap O-ST53, Rechargeable lithium-ion battery D-LI50, Battery charger D-BC50, AC plug cord, Operating Manual (this book), Quick Guide, PENTAX PHOTO Browser 3/PENTAX PHOTO Laboratory 3 Operating Manual, PENTAX REMOTE Assistant 3 Operating Manual
Languages	English, French, German, Spanish, Portuguese, Italian, Dutch, Danish, Swedish, Finnish, Polish, Czech, Hungarian, Turkish, Russian, Korean, Chinese (Traditional/Simplified) and Japanese

Glossary

AdobeRGB

Color space recommended by Adobe Systems, Inc. for commercial printing. Wider range of color reproduction than sRGB. Covers most of the color range so colors only available when printed are not lost when editing images on a computer. When image is opened by non-compatible software, the colors look lighter.

AE Metering

Brightness of subject is measured to determine exposure. In this camera, select from [Multi-segment Metering], [Center-weighted Metering] and [Spot Metering].

Aperture

The aperture increases or reduces the light beam (thickness) passing through the lens to the image sensor.

Auto Bracket

For automatically changing the shooting conditions. An image with no compensation, an underexposed image and an over-exposed image are captured. Features exposure bracket that captures images in different exposures, and extended bracket that captures images with set white balance, saturation, hue, contrast and sharpness levels.

Bright Portion

Overexposed area in the image loses contrast and appears white.

Camera Shake (Blur)

When the camera moves while the shutter is open, the entire image appears blurred. This occurs more often when shutter speed is low. Prevent camera shake by raising the sensitivity, using the flash, and raising the shutter speed. Alternatively, use a tripod to stabilize the camera. As camera shake is mostly likely to occur when pressing the shutter release button, use the Shake Reduction function, the self-timer, the remote control unit, or the cable switch to prevent camera movement.

CMOS Sensor

Photography element which converts the light entering through the lens into electric signals that create the image.

Color Space

A defined range of colors from the spectrum which are used. In digital cameras, [sRGB] is defined as the standard by Exif. In this camera, [AdobeRGB] is also used because of the richer color expression over sRGB.

Color Temperature

This numerically expresses the color of the light source illuminating the subject. This is indicated in absolute temperature, using Kelvin (K) units. The color of light shifts to a bluish color as the color temperature rises, and to a reddish color as the color temperature falls.

Dark Portion

Underexposed area in the image loses contrast and appears black.

DCF (Design Rule for Camera File System)

A digital camera file system standard established by the Japan Electronics and Information Technology Industries Association (JEITA).

Depth of field

Area of focus. This depends on the aperture, lens focal length, and distance to the subject. For example, select a smaller aperture (higher number) to increase the depth of field or use a larger aperture (smaller number) to decrease the depth of field.

DNG RAW file

DNG (Digital Negative) is a general-purpose RAW file format designed by Adobe Systems. When images captured in proprietary RAW formats are converted to DNG format, support and compatibility for the images increases significantly.

DPOF (Digital Print Order Format)

Rules for writing information onto a card with recorded images regarding the specific images and number of copies to be printed. Prints can easily be made by taking images to a DPOF photo printing store.

Dynamic Range (D-Range)

Indicated with a value expressing the light level reproducible in an image. This is the same as the term “latitude” used with silver halide film. Generally, when the dynamic range is wide, it is difficult for bright and dark areas to occur in the image, and when the dynamic range is narrow, a sharp image can be achieved.

EV (Exposure Value)

Exposure value is determined by the combination of the aperture value and the shutter speed.

EV Compensation

Process of adjusting the image brightness by changing the shutter speed and/or aperture value.

Exif (Exchangeable image file format for digital still camera)

A standard digital camera file format established by the Japan Electronics and Information Technology Industries Association (JEITA).

Focus point

Position in the viewfinder that determines focus. In this camera, select from [Auto], [Select] and [Center].

Histogram

A graph that shows the darkest and brightest points in an image. The horizontal axis represents the brightness and the vertical axis represents the number of pixels. This is useful when you wish to refer to the exposure status of an image.

ISO Sensitivity

The level of sensitivity to light. With a high sensitivity, images can be shot with a high shutter speed even in dark places, reducing camera shake. However, images with high sensitivity are more susceptible to noise.

JPEG

An image compression method. In this camera, select from ★★★★★ (Premium), ★★★ (Best), ★★ (Better), or ★ (Good). Images recorded in JPEG format are suited for viewing on your PC or for attaching to e-mail.

Mired

Proportional scale of measurement that consistently shows color change per unit. Determined by multiplying the inverse of the color temperature by 1,000,000.

ND (Neutral Density) Filter

A filter with many saturation levels that adjusts the brightness without affecting the color tone of pictures.

Noise Reduction

Process to reduce noise (image roughness or unevenness) caused by slow shutter speed or high sensitivity shooting.

NTSC/PAL

These are video output formats. NTSC is mainly used in Japan, North America, and South Korea. PAL is mainly used in Europe and in China.

Quality Level

This refers to the image compression ratio. The lower the compression, the more detailed the image. The image becomes rougher as the compression rate rises.

RAW data

Unedited image data output from the image sensor. RAW data is data before being internally processed by the camera. Camera settings at the time of capture, such as White Balance, Contrast, Saturation, and Sharpness can be set for each frame after shooting. In addition, RAW data is 12 bit data that contains 16 times the information of 8 bit JPEG and TIFF data. Rich gradations are possible. Transfer RAW data to your computer and use the provided software to create image data with different settings, such as JPEG or TIFF.

Recorded Pixels

Indicates the size of the image by the number of pixels. The more pixels that compose a picture, the larger the image size.

Shutter Speed

The length of time that the shutter is open and light strikes the image sensor. The amount of light that strikes the image sensor can be changed by altering the shutter speed.

sRGB (standard RGB)

International standard of color space established by the IEC (International Electrotechnical Commission). This is defined from color space for PC monitors and is also used as the standard color space for Exif.

Vignetting

The picture edges are blackened when part of the light coming from the subject is blocked by the hood or filter ring, or when the flash is partially blocked by the lens.

White Balance

While shooting, color temperature is adjusted to match the light source so that the subject appears to have correct color.

Index

Symbols

[C Custom Setting]

Menu 73, 170, 246

 (Delete) button 21, 70

 (EV Compensation)

button 19, 100

 (Exposure Bracket)

button 19, 129

 **UP** (Flash pop-up)

button 19, 60

 (Green mode) 83

 (Playback)

button 19, 21, 68

[ Playback] Menu 170, 245

 Preview 114

 (Protect) button 21, 189

[ Rec. Mode] Menu 72, 244

[ Set-up] Menu 216, 245

A

AC Adapter 39

Adding the Date 204

AdobeRGB 167

AE Lock 102

AE Metering 98

AE-L button 19

AF (Adjustment) 106

AF (Autofocus) 104

AF button 19, 112

AF point switching dial ... 19, 107

AF200FG 143

AF360FGZ 143

AF540FGZ 143

A.F.C (Continuous mode) 104

A.F.S (Single mode) 104

Aperture 77

Aperture Priority Mode **Av** 89

Auto Bracket 129

Auto Power Off 233

Autofocus **AF** 104

Automatic Sensitivity

Correction 78

Av (Aperture Priority) mode ... 89

AV Equipment 191

B

B (Bulb) Mode 96

B&W (Digital Filter) 195

Battery 35

Beep 219

Bright/Dark area 182

Brightness (Digital Filter) 196

Brightness level 226

Brightness of the Monitor 226

Built-in Flash 60

Bulb Mode **B** 96

Burst Shooting 119

C

Cable Switch 96

Capture Information 23, 25

Card access lamp 17

Center-weighted 99

Cloudy (White Balance) 160

Color (Digital Filter) 195

Color Space 167

Color Temperature 166

Continuous mode **A.F.C** 104

Continuous Shooting 117

Contrast 154

Contrast-Control-Sync

(Flash) 150

Correct exposure 76

Custom Image 154

Custom Setting 73, 170

[C Custom Setting]

Menu 73, 170, 246

D

Date Adjust 48

Date change 220

Daylight (White Balance) 160

Daylight-Sync Shooting 64

Delete 70, 185

Delete All Images 185

☒ (Delete) button 21, 70

Delete Folder 188

Deleting a Single Image 70

Depth of field 77

Digital Filter 194

Digital Preview 114

Diopter Adjust 52

Direct Printing 207

Display Language 224

Display Style 182

DPOF AUTOPRINT 213

DPOF Settings 204

Drive Mode 75

Dust Alert 252

Dust Removal 252

E

Error Message 261

EV Compensation 100

☒ (EV Compensation)

button 19, 100

Expand Dynamic Range 79

Exposure 76

Exposure Bracket 129

☒ (Exposure Bracket)

button 19, 129

Exposure Bracket button 129

Exposure metering timer 130

Exposure Mode 80

Exposure Warning 88, 90, 94

Extended Bracket 131

External flash 143

Extract Color (Digital Filter) .. 195

F

File Format 158

File Name 231

Filter 194

Filter Effect 154

Fireworks 96

Fix Focus 108

Flash 60, 135

Flash (White Balance) 160

Flash Exposure

Compensation 136

⚡UP (Flash pop-up)

button 19, 60

Flash X-sync Speed Mode

X 97

Fluorescent Light

(White Balance) 160

Fn button 19, 21, 75, 171

Fn Menu 75, 171

Focus Indicator 110

Focus Lock 108

Focus Mode 104

Focus mode lever 19

Focus point 107

Focusing 104

Folder Name 230

Format 218

Four-way controller

(▲▼◀▶) 19, 21

Front e-dial 18

G



Green button 18

Green mode ■ 83

Guide display 22, 225

H

HDR (Digital Filter) 196

- High-ISO Noise Reduction 80
- High-Speed Flash Sync
Mode 145
- Histogram 26, 182
- Hue 154
- Hyper-manual Mode **M** 93
- Hyper-program Mode **P** 84
- I**
- Illustration (Digital Filter) 195
- Image Comparison 178
- Image Tone 154
- INFO** button 19, 21, 23, 68
- Initial Settings 45, 244
- Input Focal Length 67
- Instant Review 227
- Interval Shooting 120
- ISO sensitivity 78
- J**
- JPEG Quality 42, 157
- JPEG Recorded
Pixels 42, 156
- L**
- Language Setting 45
- LCD Color Tuning 226
- LCD panel 29
- Lens 50, 249
- Lens unlock button 18, 51
- Live View 114, 228
- Lock Exposure 110
- M**
- M** (Hyper-manual) Mode 93
- Main switch 18, 21, 44
- Manual Exposure Mode **M** 93
- Manual focus **MF** 110
- Manual White Balance 163
- Matte Field 111
- Memory 236
- MENU** button 19, 21, 30
- Menu Operation 30
- Meter Operating Time 99
- Metering mode lever 19, 98
- MF** (Manual focus) 110
- Mirror Up 128, 255
- Mode dial 19, 32
- Monitor 22
- Multi-exposure 103
- Multiple Flashes 149
- Multi-segment 98
- N**
- Night Scene (Bulb Mode) 96
- Nine-Image Display 175
- Noise Reduction 80
- NTSC 233
- O**
- OK** button 19, 21
- Optical Preview 115
- Optional Accessories 256
- P**
- P** (Hyper-program) Mode 84
- PAL 233
- PictBridge 207
- Pixel Mapping 235
- Pixels 156
- Playback 25, 68
-  (Playback)
button 19, 21, 68
- Playback display 184
- [ Playback] Menu 170, 245
- Playback time 38
- Power 44
- Press fully 57
- Press halfway 57
- Preview  114
- Preview Method 113
- Print All Images 212

Print Service	204
Print Single Image	210
Printer connection	209
Program Line	82
Program Mode P	84
Protect	189
 (Protect) button	21, 189
P-TTL (Flash)	148
P-TTL Auto (Flash)	144

Q

Quality Level	42, 157
---------------------	---------

R

RAW	158
RAW button	19, 158, 159
RAW Display	197
RAW file format	158
RAW+	158
Rear e-dial	19
[ Rec. Mode] Menu	72, 244
Recordable image no.	38
Recorded Pixels	42, 156
Red-eye reduction	64, 148
Remote Control	125
Reset	237, 244
Rotate	172

S

Saturation	154
SD Memory Card	40
Select battery	234
Select&Delete	186
Select&Edit	198
Self-timer	122
Sensitivity	78

Sensitivity Priority Mode	
---------------------------	--

Sv	85
Sensor Cleaning	252
Sepia (Digital Filter)	195
[ Set-up] Menu	216, 245

Shade (White Balance)	160
Shake Reduction	65
Shake Reduction switch ...	19, 65
Sharpness	154
Shutter & Aperture Priority Mode	
TAv	91
Shutter Priority Mode Tv	87
Shutter release button	
.....	18, 21, 57
Shutter Speed	76
Single mode AfS	104
Slideshow	179, 181
Slim (Digital Filter)	196
Slow Shutter Speed NR	80
Slow-speed sync	60, 139
Soft (Digital Filter)	195
Spot Metering	99
sRGB	167
Strap	34
Superimpose AF Area	28, 107
Sv (Sensitivity Priority)	
Mode	85

T

TAv (Shutter & Aperture Priority)	
Mode	91
Text Size	225
Toning	154
Trailing curtain sync	
.....	60, 140, 148
Tungsten Light	
(White Balance)	160
TV	191
Tv (Shutter Priority) mode	87

U

USB cable	207
USB Connection	208
USER Mode	133
Using aperture ring	251

V

Video cable	191
Video Output Format	233
Viewfinder	27, 52
Vignetting	274

W

White Balance	160
Wireless Mode (Flash)	145
World Time	221

X**X** (Flash X-sync Speed)

mode	97
X-sync socket	151

Z

Zoom Display	173
Zoom Lens	59

WARRANTY POLICY

All PENTAX cameras purchased through authorized bona fide photographic distribution channels are guaranteed against defects of material or workmanship for a period of twelve months from date of purchase. Service will be rendered, and defective parts will be replaced without cost to you within that period, provided the equipment does not show evidence of impact, sand or liquid damage, mishandling, tampering, battery or chemical corrosion, operation contrary to operating instructions, or modification by an unauthorized repair shop. The manufacturer or its authorized representatives shall not be liable for any repair or alterations except those made with its written consent and shall not be liable for damages from delay or loss of use or from other indirect or consequential damages of any kind, whether caused by defective material or workmanship or otherwise; and it is expressly agreed that the liability of the manufacturer or its representatives under all guarantees or warranties, whether expressed or implied, is strictly limited to the replacement of parts as hereinbefore provided. No refunds will be made on repairs by non-authorized PENTAX service facilities.

Procedure During 12-month Warranty Period

Any PENTAX which proves defective during the 12-month warranty period should be returned to the dealer from whom you purchased the equipment or to the manufacturer. If there are no representatives of the manufacturer in your country, send the equipment to the manufacturer, with postage prepaid. In this case, it will take a considerable length of time before the equipment can be returned to you owing to the complicated customs procedures required. If the equipment is covered by warranty, repairs will be made and parts replaced free of charge, and the equipment will be returned to you upon completion of servicing. If the equipment is not covered by warranty, regular charges of the manufacturer or of its representatives will apply. Shipping charges are to be borne by the owner. If your PENTAX was purchased outside of the country where you wish to have it serviced during the warranty period, regular handling and servicing fees may be charged by the manufacturer's representatives in that country. Notwithstanding this, your PENTAX returned to the manufacturer will be serviced free of charge according to this procedure and warranty policy. In any case, however, shipping charges and customs clearance fees to be borne by the sender. To prove the date of your purchase when

required, please keep the receipt or bills covering the purchase of your equipment for at least a year. Before sending your equipment for servicing, please make sure that you are sending it to the manufacturer's authorized representatives or their approved repair shops, unless you are sending it directly to the manufacturer. Always obtain a quotation for the service charge, and only after you accept the quoted service charge, instruct the service station to proceed with the servicing.

- **This warranty policy does not affect the customer's statutory rights.**
- **The local warranty policies available from PENTAX distributors in some countries can supersede this warranty policy. Therefore, we recommend that you review the warranty card supplied with your product at the time of purchase, or contact the PENTAX distributor in your country for more information and to receive a copy of the warranty policy.**



The CE Mark is a Directive conformity mark of the European Union.

For customers in USA**STATEMENT OF FCC COMPLIANCE**

This device complies with Part 15 of the FCC Rules. Operation is subject to the following two conditions: (1) This device may not cause harmful interference, and (2) this device must accept any interference received, including interference that may cause undesired operation.

Changes or modifications not approved by the party responsible for compliance could void the user's authority to operate the equipment.

This equipment has been tested and found to comply with the limits for a Class B digital device, pursuant to part 15 of the FCC Rules.

These limits are designed to provide reasonable protection against harmful interference in a residential installation. This equipment generates, uses and can radiate frequency energy and, if not installed and used in accordance with the instructions, may cause harmful interference to radio communications. However, there is no guarantee that interference will not occur in a particular installation.

If this equipment does cause harmful interference to radio or television reception, which can be determined by turning the equipment off and on, the user is encouraged to try to correct the interference by one or more of the following measures:

- Reorient or relocate the receiving antenna.
- Increase the separation between the equipment and receiver.
- Connect the equipment into an outlet on a circuit different from that to which the receiver is connected.
- * Consult the dealer or an experienced radio/TV technician for help.

For customers in Canada

This Class B digital apparatus complies with Canadian ICES-003.

Pour les utilisateurs au Canada

Cet appareil numérique de la classe B est conforme à la norme NMB-003 du Canada.

FOR CALIFORNIA, U.S.A. ONLY

Perchlorate Material-special handling may apply.

The lithium battery used in this camera contains perchlorate material, which may require special handling.

See www.dtsc.ca.gov/hazardouswaste/perchlorate

Declaration of Conformity

According to 47CFR, Parts 2 and 15 for Class B Personal Computers and Peripherals

We: PENTAX Imaging Company
A Division of PENTAX of America, Inc.

Located at: 600 12th Street, Suite 300
Golden, Colorado 80401 U.S.A.
Phone: 303-799-8000 FAX: 303-790-1131

Declare under sole responsibility that the product identified herein complies with 47CFR Parts 2 and 15 of the FCC rules as a Class B digital device. Each product marketed is identical to the representative unit tested and found to be compliant with the standards. Records maintained continue to reflect the equipment being produced can be expected to be within the variation accepted, due to quantity production and testing on the statistical basis as required by 47CFR §2.909. Operation is subject to the following two conditions: (1) This device may not cause harmful interference, and (2) This device must accept any interference received, including interference that may cause undesired operation. The above named party is responsible for ensuring that the equipment complies with the standards of 47CFR §15.101 to §15.109.

Product Name: PENTAX Digital Still Camera

Model Number: ***K20D***

Contact person: Customer Service Manager

Date and Place: February, 2008, Colorado

Information on disposal for users



1. In the European Union

If your product is marked with this symbol, it means that used electrical/electronic products should not be mixed with general household waste. There exists a separate collection system for these products.

Used electric/electronic equipment must be treated separately and in accordance with legislation that requires proper treatment, recovery and recycling of these products. Following the implementation by member states, private households within the EU states may return their used electrical/electronic equipment to designated collection facilities free of charge*. In some countries your local retailer may also take back your old product free of charge if you purchase a similar new one.

*Please contact your local authority for further details.

By disposing of this product correctly you will help ensure that the waste undergoes the necessary treatment, recovery and recycling and thus prevent potential negative effects on the environment and human health which could otherwise arise due to inappropriate waste handling.

2. In other countries outside the EU

If you wish to discard this product, please contact your local authorities and ask for the correct method of disposal.

For Switzerland: Used electrical/electronic equipment can be returned free of charge to the dealer, even when you don't purchase a new product. Further collection facilities are listed on the home page of www.swico.ch or www.sens.ch.

Memo